

Classification and type synthesis of 1-DOF remote center of motion mechanisms

Guanghua Zong, Xu Pei *, Jingjun Yu, Shusheng Bi

Robotics Institute, Beihang University, Beijing 100083, China

Received 2 February 2007; received in revised form 13 December 2007; accepted 23 December 2007

Available online 7 February 2008

Abstract

Type synthesis of 1-DOF remote center of motion (RCM) mechanisms is the preliminary for research on many multi-DOF RCM mechanisms. Since types of existing RCM mechanisms are few, it is necessary to find an efficient way to create more new RCM mechanisms. In this paper, existing 1-DOF RCM mechanisms are first classified, then base on a proposed concept of the planar virtual center (VC) mechanism, which is a more generalized concept than a RCM mechanism, two approaches of type synthesis for 1-DOF RCM mechanisms are addressed. One case is that a 1-DOF parallel or serial–parallel RCM mechanism can be constructed by assembling two planar VC mechanisms; the other case, a VC mechanism can be expanded to a serial–parallel RCM mechanism. Concrete samples are provided accordingly, some of which are new types.

© 2008 Elsevier Ltd. All rights reserved.

Keywords: Type synthesis; Remote center of motion; Parallel mechanism; Virtual center of motion

1. Introduction

A general mechanism is made up of parts and joints. If a part of the mechanism can rotate around a fixed point distal from the mechanism, and there are no physical revolute joint at the fixed point, then this mechanism may be called a remote center of motion (RCM) mechanisms [1].

The RCM mechanisms are initially developed to position and manipulate tools or endoscopes in some minimally invasive surgery (MIS) or surgery robotic applications. During MIS, surgical tools or trocars (cm size) pass through small incisions to reach the surgical site. The entry point as a kinematical constraint acts as a pivot that the tools have to be moved in a spherical configuration. The introduction of RCM mechanisms in MIS provides a fixed entry point (coincided with RCM point) of the endoscope into the patient's body during the whole operation process, enhances safety and quality of the surgery, and gives facilities for surgeons.

* Corresponding author. Tel.: +86 010 82338019.
E-mail address: peixu@me.buaa.edu.cn (X. Pei).

Such mechanisms have been used widely in robot assisted surgery applications, such as the wrist module of Da Vinci surgical system [2]. In fact, almost all commercially endoscope surgical robots are RCM-based robots.

Taylor is the first to apply RCM concept to a laparoscopic robot [1]. Variants of such robots have been developed [3,4], including MINI-RCM&PAKY robot, Steady Hand Robot, etc. In addition, Kim et al. [5] designed a 6-DOF MR-compatible RCM manipulator for minimally invasive liver surgery. Baumann et al. [6] proposed a 2-DOF parallel RCM force reflecting manipulator, named PantoScope. Faraz and Payandeh [7] made some primary research on type synthesis of 2-DOF RCM mechanisms. Zoppi et al. [8] provided a fully parametric analytical model of the inverse kinematics of a class of 4-DOF RCM parallel manipulators.

However, current research on RCM mechanisms is very limited in mechanics, including lacking of type synthesis, which is one of the most important issues on constructing a novel mechanism. As a result, types of RCM mechanisms are limited, and effective methods to achieve type synthesis for RCM mechanisms are also scanty.

Although most RCM mechanisms in applications should be implemented at least two rotational DOFs around the RCM point, these mechanisms can be consisted of two 1-DOF RCM mechanisms. So the investigation on 1-DOF RCM mechanisms is primary important for the proposal of multi-DOF RCM mechanisms. In this paper, the type synthesis of 1-DOF RCM mechanisms is addressed, to give an overview of such mechanisms, and present some new ways to find more types of RCM mechanisms. For this purpose, the classification of existing RCM mechanisms is first presented in Section 2. The concept of virtual center mechanism (VC mechanism), which is the generalization of RCM mechanism, is introduced in Section 3. Two type synthesis approaches based on combination and expansion of virtual center mechanism are addressed in Sections 4 and 5, respectively. Finally, conclusions are drawn.

2. Classification of 1-DOF RCM mechanisms

2.1. Single-revolute-joint RCM mechanisms

As well known, if a link is connected by a revolute joint at its end, all points excluding the axis of the revolute joint in this link are rotated around the axis. In this case, any point on the axis can be considered as a RCM point. Thus a 1-DOF RCM mechanism can be constructed as shown in Fig. 1.

This kind of RCM mechanism usually acts as a basic component or module of a 2-DOF or multi-DOF RCM mechanism due to its simple structure. For instance, Lum [9] designed an embodiment of 2-DOF RCM mechanism is composed of two revolute joints.

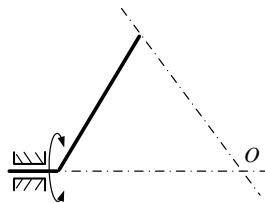

Fig. 1. Single-revolute-joint RCM mechanisms.

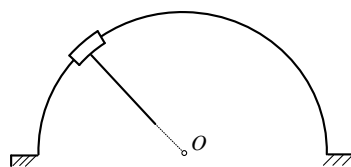

Fig. 2. Circular-prismatic-joint RCM mechanisms.

2.2. Circular-prismatic-joint RCM mechanisms

Some RCM mechanisms are made up of a circular-prismatic joint (Fig. 2), such as the SMOS robot proposed by Guerrouad and Vidal [10]. The advantage of this kind of mechanism lies in its compactness. However, fixed RCM point, limited rotational range, large occupied space, and high precision needed in manufacture and assembly surely limited its usage.

2.3. Parallelogram-based RCM mechanisms

The most familiar RCM mechanisms in applications are based on parallelograms, which can easily compose a 2-DOF RCM mechanism [3,4,9].

Fig. 3a shows a basic configuration of parallelogram-based RCM mechanisms. It is noteworthy that there exist redundant constraints in the BCDE loop. Thus by eliminating different redundant constraints, several other configurations can be derived, as shown from Fig. 3b–f. This family of RCM mechanism has many advantages including a relatively large movement range, a simple structure, the driver placed at the base of linkage, and the adjustable position of RCM point by bending the links. On the other hand, the disadvantages of parallelogram-based RCM mechanisms are also obvious, such as intervention between linkages, singularity of parallelogram linkages, and lacking absolute rigidity due to a large number of revolute joints.

2.4. Synchronous-transmission-based RCM mechanisms

Fig. 4 shows a belt driving system, whose transmission ratio is equal to 1. In this system, the orientation of two wheels is the same. Such a synchronous-transmission system can be regarded as a substitution of parallelogram linkage. In addition, all equal-ratio synchronous transmissions can be used to replace parallelogram linkages, such as belt, gear, chain, etc. Fig. 4 uses a synchronous-transmission system to replace a set of parallelogram linkage. Or two sets of parallelogram linkage can be replaced, such as a Mini RCM mechanism [3] with two set of tooth synchronous belt transmission systems.

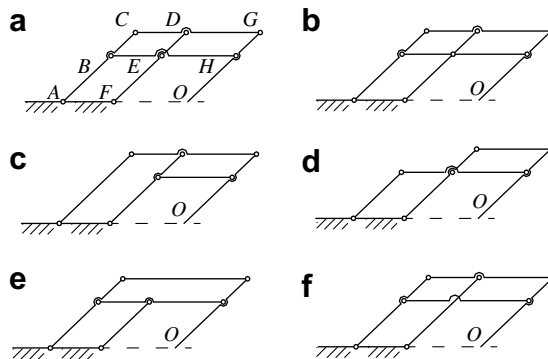

Fig. 3. Parallelogram-based RCM mechanisms.

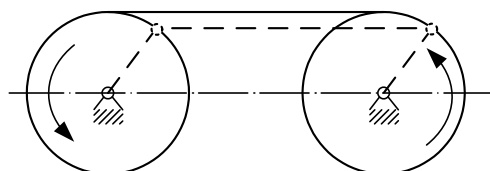

Fig. 4. Synchronous-transmission RCM mechanisms.

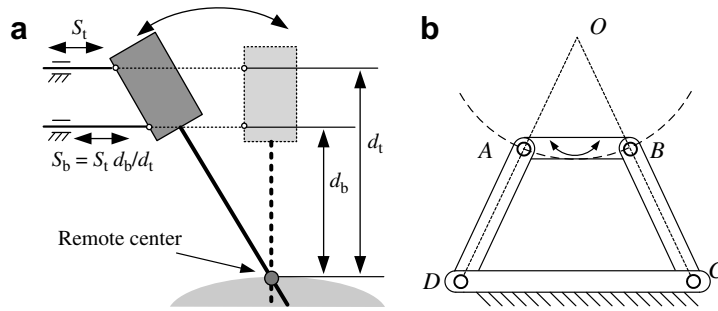

Fig. 5. Instantaneous RCM mechanisms.

2.5. Instantaneous RCM mechanisms

Some RCM mechanisms do not strictly accord with the definition of RCM mechanisms. But, in some cases, they are also useful. For example, the mechanism developed by Kim et al. [5] consists of two prismatic pairs perpendicular to the end-effector; and the ratios of their displacements is equal to the ratios of the distances between them and the RCM point, respectively, i.e. $S_b/S_t = d_b/d_t$. As a result, the end-effector can approximately rotate around a fixed point (see Fig. 5a). However, a parasitical movement along the end-effector axis occurs at the same time.

In an isosceles trapezoid four-bar link shown in Fig. 5b, there is an instantaneous RCM at point O. Assuming that the angular rotation is small and the link DC is fixed on the base, the motion of the link AB can be considered that rotated around the point O. In other words, the point O is an instantaneous RCM of this isosceles trapezoid structure. However, with increment of rotational angle, the center will shift seriously. Such mechanism prefers using in a flexure system [11] for some micro-positioning applications.

3. Virtual center mechanisms

To find more novel RCM mechanisms, a more generalized concept relative to RCM mechanisms is introduced. Such a mechanism is referred to as a virtual center (VC) mechanism. Here only planar VC mechanisms will be concerned and defined.

There are many circular motion mechanisms in mechanics, in part of which there exists no physical revolute joint at the center of motion. As shown in Fig. 6, a point (such as point E) in a link of a parallelogram mechanism can be rotated around a fixed point (such as point O) within the plane. However, no physical revolute joint is needed at this point. In other words, there is a redundant constraint between points E and O. Such a mechanism is defined as a planar VC mechanism. The point E is a circular motion point about the center point O.

On the other hand, if a link of the planar mechanism can rotate around a fixed point within a plane, and no physical revolute joint exists at the fixed point, the mechanism is defined as a planar virtual center of motion (VCM) mechanism.

The difference between a VC mechanism and a VCM mechanism is that one or more points can rotate around a fixed point in a VC mechanism, but at least a link can rotate around a fixed point in a VCM mechanism. Thus it can be easily concluded that the concept of VCM is included in VC. After all, if a link of the

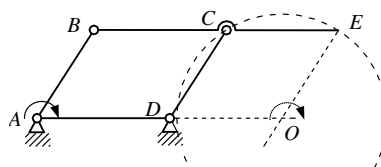

Fig. 6. Parallelogram VC mechanism.

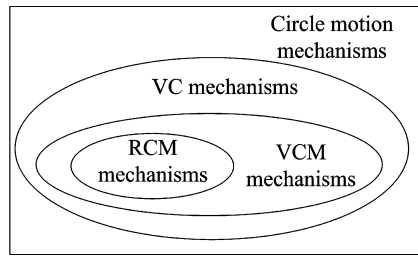

Fig. 7. The hierarchy relationship of the concept mentioned above.

mechanism can rotate around a virtual center, all points in it can rotate around the center point. The difference between a VCM mechanism and a RCM mechanism lies in the position of virtual center. The virtual center of a RCM mechanism is distant from the mechanism, but in a VCM mechanism, the virtual center can be located anywhere. So the concept of RCM is an inclusion of that of a VCM. The hierarchy relationship of them is illustrated in Fig. 7.

Since VC is a more generalized concept than VCM, it is possible to create a new VCM mechanism by combining or expanding VC mechanisms (not VCM mechanisms). Then, RCM mechanisms can be further synthesized provided that some geometric constraints could be satisfied.

The majority of known VC mechanisms can be found in some professional mechanical manuals. Fig. 8 gives only four typical VC mechanisms.

Links of the mechanism shown in Fig. 8(a) should satisfy: (1) $AC/CF = AB/BE = ED/DF = EG/FO$; (2) $BCDE$ is a parallelogram; (3) points A, E, F are collinear. The position of virtual center O can be determined by geometric conditions $FO // EG$, and points A, G, O are also collinear. When link EG rotates around joint G , point F will rotate around point O . The structure shown in Fig. 8b is symmetric, and $BCDE$ is a rhombus. The virtual center O is symmetric with joint A about line CE . In Fig. 8c, links CG and EF are connected with the base by joint D , and forming two parallelograms with all sides equal on both sides of joint D , respectively. The virtual center O is centro-symmetric with joint A , the center of symmetry is point D . Fig. 8d shows a Sylvester pantograph mechanism. If $ABCD$ is a parallelogram, and $\triangle BGC \cong \triangle DCE$, then the trajectory generated by point G is similar to one generated from point E . The angle between links FE and OG equals to $\angle GAE = \angle CDE = \angle GBC$, and lengths of links satisfy condition: $FE/OG = AE/AG = DE/DC$.

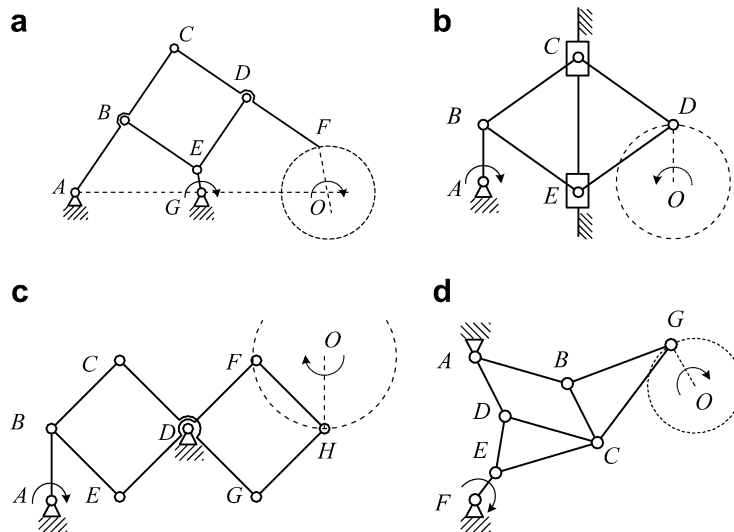

Fig. 8. Four typical VC mechanisms.

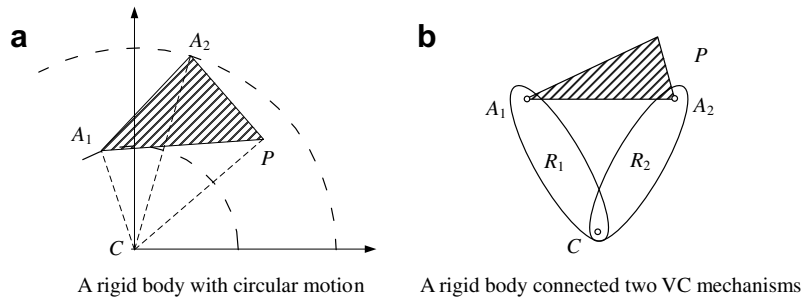

Fig. 9. Rotational rigid bodies. (a) A rigid body with circular motion; (b) a rigid body connected two VC mechanisms.

4. Type synthesis method I – combination of two VC mechanisms

Considering the kinship between VC and VCM or RCM, a new VCM or RCM mechanism can be constructed by combination of two VC mechanisms.

Theorem. *If any two distinct points in a rigid body can move along the concentric circles, and the two points are not collinear with the center, then the rigid body must accomplish a circular motion whose center is coincided with that of the concentric circle.*

Proof. With reference to Fig. 9a, letting A_1, A_2 be the two distinctive points of a rigid body, each of them can move along a concentric circle centered at point C , while point P is a generic point in the same rigid body. Here, we need to prove that point P can also rotate around center C .

When the rigid body moves, the lengths $\overline{CA_1}, \overline{CA_2}$ are constant, since points A_1, A_2 and P are all points in the same rigid body, the lengths $\overline{A_1A_2}, \overline{A_1P}$ and $\overline{A_2P}$ are also constant, and hence

$$\begin{cases} \angle A_1A_2P = \text{const} \\ \angle CA_2A_1 = \text{const} \end{cases} \Rightarrow \angle CA_2P = \text{const}$$

and

$$\begin{cases} \overline{CA_2} = \text{const} \\ \overline{A_2P} = \text{const} \end{cases}$$

We will then obtain

$$\overline{CP} = \text{const}$$

That is to say that the triangle CA_2P keeps rigid, so point P can rotate around the center C . □

According to theorem, if two VC mechanisms, such as R_1 and R_2 in Fig. 9b, both of which have one common virtual center C , are connected by a rigid body A_1A_2P through two revolute joints, the two connected joints will move along the concentric circles, and A_1A_2P rotates around the center C . By employing this method, some novel 1-DOF parallel RCM mechanisms can be easily constructed. The detailed procedures are given as follows.

- Step 1.* Choose two VC mechanisms as elements, they may be the same type or not. Two same parallelogram VC mechanisms are chosen as two elements in the example shown in Fig. 10a.
- Step 2.* Adjust positions and orientations of two VC mechanisms and change their kinematical parameters to make their virtual center coincided. Make sure that the two circular motion points (such as points A and B in Fig. 10a) and the virtual center are not aligned. In Fig. 10a, two elemental VC mechanisms are distributed symmetrically, and the common virtual center is point O .
- Step 3.* Add a revolute joint at the circular motion point whose rotational center is point O (such as points A, B in Fig. 10a) in each VC mechanism, then connect the two joints with a link. The link can then rotate

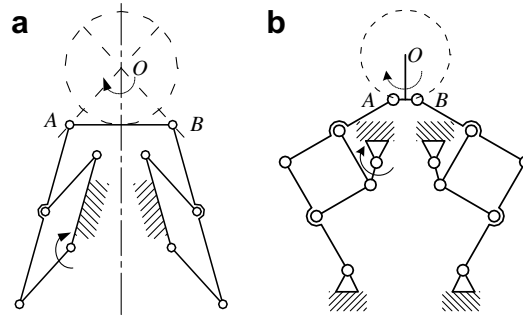

Fig. 10. 1-DOF parallel RCM mechanisms.

around center O . Delete all redundant links, the resultant mechanism will be a VCM mechanism. In the case that the virtual center is distant from the mechanism, it will be a RCM mechanism.

Using this method, some new 1-DOF parallel RCM mechanisms can be obtained. Fig. 10 outlines two of them. In the mechanism shown in Fig. 10a, link AB rotates around the point O which is out of the mechanism. In the Fig. 10b, the RCM mechanism consisted of two VC mechanisms shown in Fig. 7a symmetrically. This mechanism can be designed to avoid singularity, and it has a larger workspace than the one shown in Fig. 10a.

Another advantage of this method includes that the position of RCM can be arranged flexibly. What is more important, the position of RCM can be adjustable. Fig. 11 shows an embodiment of mechanism shown in Fig. 10a. The motor drives the link at the base, enabling the upper moving platform to rotate around the virtual center. By adjusting a screw stud, the distance between A and B (Fig. 10a) changes, which can further change the distance from the moving platform to the virtual center. Such mechanisms can be used for components or modules in leveling or alignment applications.

With the combination of two VC mechanisms, not only parallel RCM mechanisms but also serial–parallel RCM mechanisms can be constructed, such as a parallelogram-based RCM mechanism. The detailed procedures are given as follows.

Step 1. Two VC mechanisms are chosen as elements. Noted that in the two elemental VC mechanisms, the rotational orientations between driving links (such as link AB in Fig. 6) and the circle motion points (such as point E in Fig. 6) keep the same. For instance, two identical parallelogram VC mechanisms

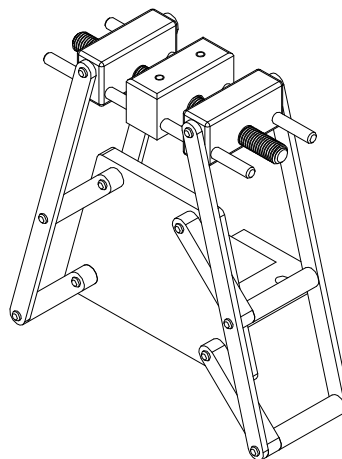

Fig. 11. An adjustable RCM mechanisms.

are chosen as two elements in the example shown in Fig. 12a. However, the example shown in Fig. 12b employs two VC mechanisms with different types as two elements. One is a pantograph mechanism; the other is a parallelogram VC mechanism.

- Step 2. Adjust positions and orientations of two VC mechanisms and change their kinematical parameters to make their virtual centers, driving links and parts of other links coincided. In Fig. 12a, the driving links AB and $A'B'$, links CD and $C'D'$ should be coincident, and the virtual center is point O . In Fig. 12b, the driving link of pantograph mechanism is link EG , it should be coincided with driving link $C'D'$ of the parallelogram VC mechanism. Moreover, Links AB and $A'B'$ should be coincident.
- Step 3. Add a revolute joint at the circular motion point in each VC mechanism, then connect two joints with a link which can rotate around center O . Deleting all redundant links, the resultant mechanism will be a VCM mechanism.

Fig. 12 illustrates processes of synthesizing two kinds of serial–parallel RCM mechanisms by employing the method described above. The mechanism in Fig. 12a is indeed a parallelogram-based RCM mechanism (Fig. 7), whilst the one shown in Fig. 12b is a new RCM mechanism.

5. Type synthesis method II – expansion of a VC mechanism

Comparing VC mechanisms (Fig. 6) with RCM (VCM) mechanisms (Fig. 3), it can be discovered that they are somehow similar to each other except constraint conditions. Hence by adding some constraints and links in a proper manner, a VC mechanism can be derived into a RCM mechanism.

Firstly, concept of DCC (degree of combinational constraint) represented by u is introduced. The DCC represents the expectable constraint capacity of a limb combined of links and joints. It is given by

$$u = M - 1 \times \text{DOF}$$

where M is the degree of freedom of a unconnected link, which is 6 in three-space and is 3 in a plane. DOF is the number of degree of freedom of the limb.

In the case of planar mechanisms, the above equation could also be written as

$$u = 2J_1 + J_2 - 3L$$

where, L is the number of links; J_1 is the number of 1 DOF joints; and J_2 is the number of 2 DOF joints. For instance, the DCC of a revolute joint is 2, which indicates a revolute joint can constrain two independent motions in the plane. For the combination of one link and two revolute joints shown in Fig. 13a, the corresponding DCC is 1.

As illustrated in Fig. 13, we can follow four steps to construct a RCM mechanism.

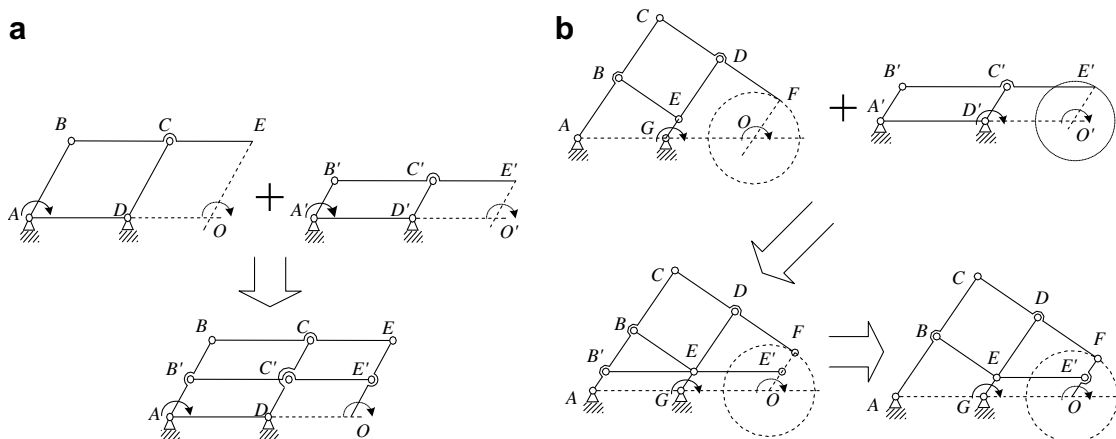

Fig. 12. Processes of constructing a serial–parallel RCM mechanism.

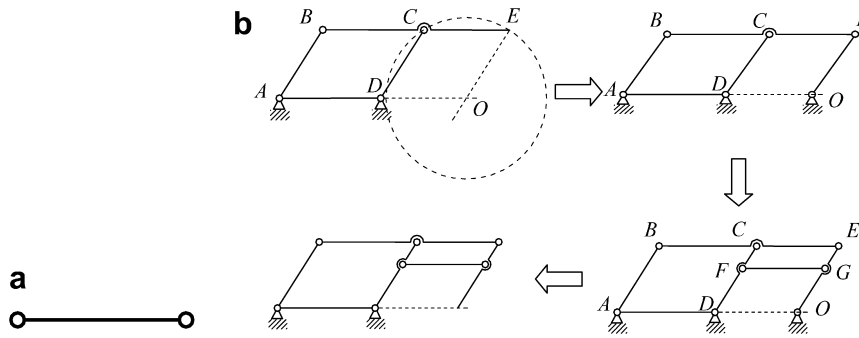

Fig. 13. Schematic of type synthesis method II.

- Step 1. Add a link between the circular motion point (point E) and virtual center point (point O) in a selected VC mechanism. For convenience, the link will be called virtual link in the context. The link is jointed to the base at the virtual center.
- Step 2. Find a combination of links and joints whose $DCC > 0$. Connect the virtual link with the VC mechanism at a proper position (in general case, the driving link is chosen, such as link CD in Fig. 13b). If the connection does not affect the motion characteristics of the mechanism, in other words the DOF of new mechanism is still 1, the mechanism can be derived into a VCM mechanism.
- Step 3. Removing all redundant links and the joint between virtual link and the base, thus a VCM mechanism can be obtained.
- Step 4. Setting up the position of the VCM point, the VCM mechanism is derived into a RCM mechanism.

According to the difference in geometric distribution between the driving link and the virtual link, there are four cases illustrated as follows:

- (1) As illustrated in Fig. 14a, when the driving link AB and the virtual link OE in a VC mechanism keep parallel to each other during the linkage moving, a link can be added between the two links to construct

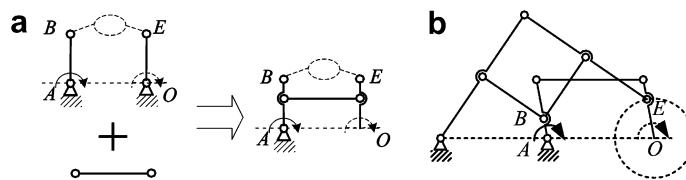

Fig. 14. The driving link and the virtual link keep parallel to each other.

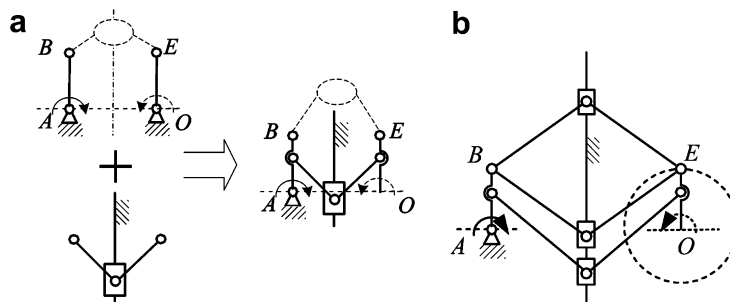

Fig. 15. The driving link and the virtual link keep line-symmetry.

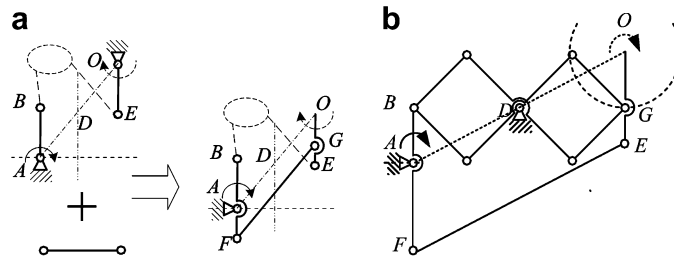

Fig. 16. The driving link and the virtual link keep center-symmetric.

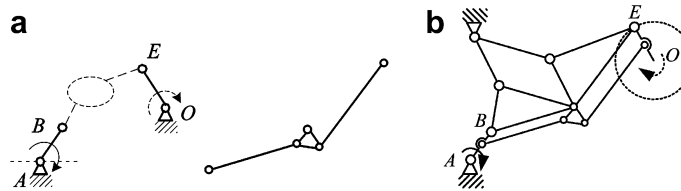

Fig. 17. The angle between the driving link and the virtual link is a constant.

a VCM mechanism. As a concrete case, it is noticed that the driving link is always parallel to the virtual link in the VC mechanisms shown in Fig. 8a, therefore, a novel RCM mechanism may be constructed by this way, as illustrated in Fig. 14b.

- (2) As illustrated in Fig. 15a, when the two links in a VC mechanism keep line-symmetry during the linkage moving, a linkage can be added between the driving link AB and the virtual link OE to construct a VCM mechanism. As a concrete case, Fig. 15b illustrates a novel RCM mechanism created by the VC mechanism shown in Fig. 8b.
- (3) As illustrated in Fig. 16a, when the two links in a VC mechanism keep centro-symmetric during the linkage moving, a link FG can be added between the driving link AB and the virtual link OE to construct a VCM mechanism. As a concrete case, Fig. 16b illustrates a novel RCM mechanism created by the VC mechanism shown in Fig. 8c.
- (4) As illustrated in Fig. 17a, when the two links in a VC mechanism keep a fixed angle (not zero) during the linkage moving, a linkage can be added between the driving link AB and the virtual link OE to construct a new VCM mechanism. As a concrete case, Fig. 17b illustrates a novel RCM mechanism created by VC mechanism shown in Fig. 8d.

6. Conclusions

As a kind of deficient-DOF system, a RCM mechanism has many potential applications in surgical assistant robot, leveling or alignment devices, etc. In this paper, the classification of 1-DOF RCM mechanisms is proposed first. Then, two type synthesis methods of 1-DOF RCM (or VCM) mechanisms are addressed by combining or expanding VC mechanisms. Some new 1-DOF RCM mechanisms can be synthesized effectively by using two type synthesis methods mentioned above.

The common point in these two methods is that RCM mechanisms are derived by using different VC mechanisms. Once a new VC mechanism is found, the new RCM mechanisms may be constructed accordingly. In fact, because the concept of VC mechanism is broader than RCM mechanisms, to find a VC mechanism is much easier than to find a RCM mechanism directly.

However, there are some differences between these two methods. Method I is comparably convenient to construct parallel RCM mechanisms, and easy to implement as well. The position of RCM in the synthesized mechanism can be arranged flexibly. But the structure of constructed mechanism is usually complex. Method I is also used to synthesize serial-parallel RCM mechanisms. Because the Theorem 4 is a general rule, the

Method I can be used to construct almost all the planar 1-DOF VCM mechanism. Method II is convenient to construct serial–parallel RCM mechanisms. But the linkage added latter in this method depends on the configuration of the VC mechanism, which would need more experiences and inspirations for the researcher.

Acknowledgements

The authors would like to acknowledge the support of National Natural Science Foundation of China, through Grant No. 50405007, Beijing Nova Program (2006A13), and the Innovation Foundation of BUAA for PhD Graduates.

References

- [1] S.J. Blumenkranz, D.J. Rosa, Manipulator positioning linkage for robotic surgery, US 6246200, 2001.
- [2] R.H. Taylor, J. Funda, D. LaRose, M. Treat, A telerobotic system for augmentation of endoscopic surgery, in: Proceedings of the Annual International Conference, 1992, pp. 1054–1056.
- [3] R.H. Taylor, J. Fundal, B. Eldridge, et al., A telerobotic assistant for laparoscopic surgery, *Engineering in Medicine and Biology Magazine* 14 (3) (1995) 279–288.
- [4] R.H. Taylor, A. Barnes, R. Kumar, et al., A steady-hand robotic system for microsurgical augmentation, in: The Second International Conference on Medical Image Computing and Computer-Assisted Intervention, Cambridge, England, 1999.
- [5] D. Kim, E. Kobayashi, T. Dohi, et al., A new, compact MR-compatible surgical manipulator for minimally invasive liver surgery, in: Proceedings of 5th International Conference on Medical Image Computing and Computer-Assisted Intervention, Tokyo, Japan, 2002, pp. 164–169.
- [6] R. Baumann, W. Maeder, D. Glauser, R. Clavel, The PantoScope: A spherical remote-center-of-motion parallel manipulator for force reflection, in: Proceedings of the 1997 IEEE International Conference on Robotics and Automation, Albuquerque, New Mexico, pp. 718–723.
- [7] A. Faraz, S. Payandeh, A robotic case study: optimal design for laparoscopic positioning stands, *The International Journal of Robotics Research* 17 (9) (1998) 986–995.
- [8] M. Zoppi, D. Zlatanov, C.M. Gosselin, Analytical kinematics models and special geometries of a class of 4-DOF parallel mechanisms, *IEEE Transactions on Robotics* 21 (6) (2005) 1–10.
- [9] M. Lum, Kinematic Optimization of a 2-DOF Spherical Mechanism for a Minimally Invasive Surgical Robot, University of Washington, Washington, 2004.
- [10] A. Guerrouad, P. Vidal, Stereotaxical microtelemanipulator for ocular surgery, in: Proceedings of the Annual International Conference of the IEEE Engineering in Medicine and Biology Society, Seattle, WA, 1989, pp. 879–880.
- [11] S. Henein, C. Aymon, S. Bottinelli, et al., Articulated structures with flexible joints dedicated to high precision robotics, in: International Advanced Robotic Programme, Moscow, 1999, pp. 135–140.