

Endoscopic Reconstruction with Robust Feature Matching

Checkpoint Presentation for CIS II Course Project

Xiang Xiang

Mentors: Dr. Dan Mirota, Dr. Greg Hager and Dr. Russ Taylor

Computer Science, JHU

Mar. 26, 2013

Outline

- Project Review
- Progress: Feature Matching Statistics
- Discussion

Goal of this course project

- To develop methods for surface reconstruction from endoscopic videos.
 - To build up the 3D endoscopic reconstruction pipeline.
 - To validate the pipeline's performance under a baseline design.
 - To test the pipeline's performance with improved components such as more robust feature matching.

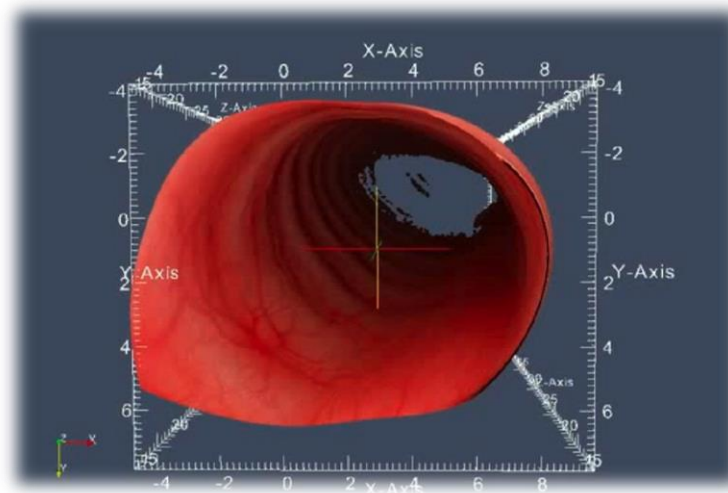

A full 3D reconstruction of a pediatric airway from video imagery acquired with a tracked endoscope. [Image from a NIH-funded project proposal with permission.]

Significance of this course project

- Since the camera is moving and the surfaces are more or less deformable, feature matching is not always satisfactory.
- We will employ a state-of-the-art feature description and matching strategy called Hierarchical Multi-Affine (HMA) for endoscopic feature representation.

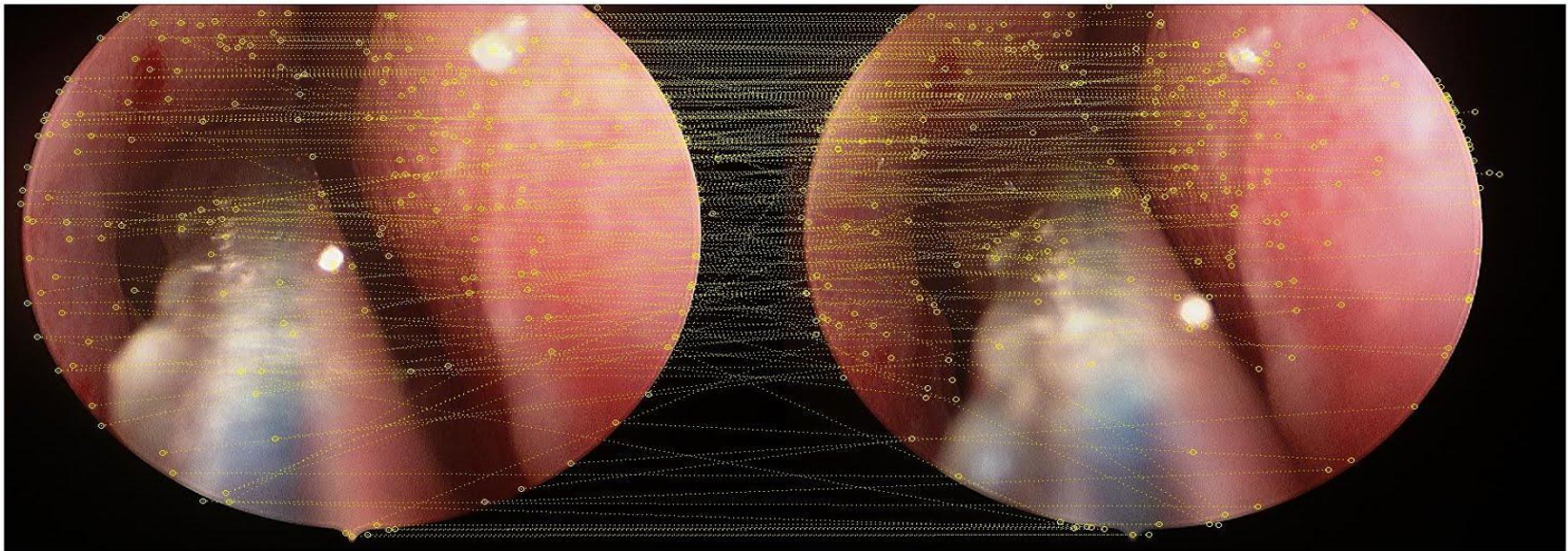

Approach: the pipeline

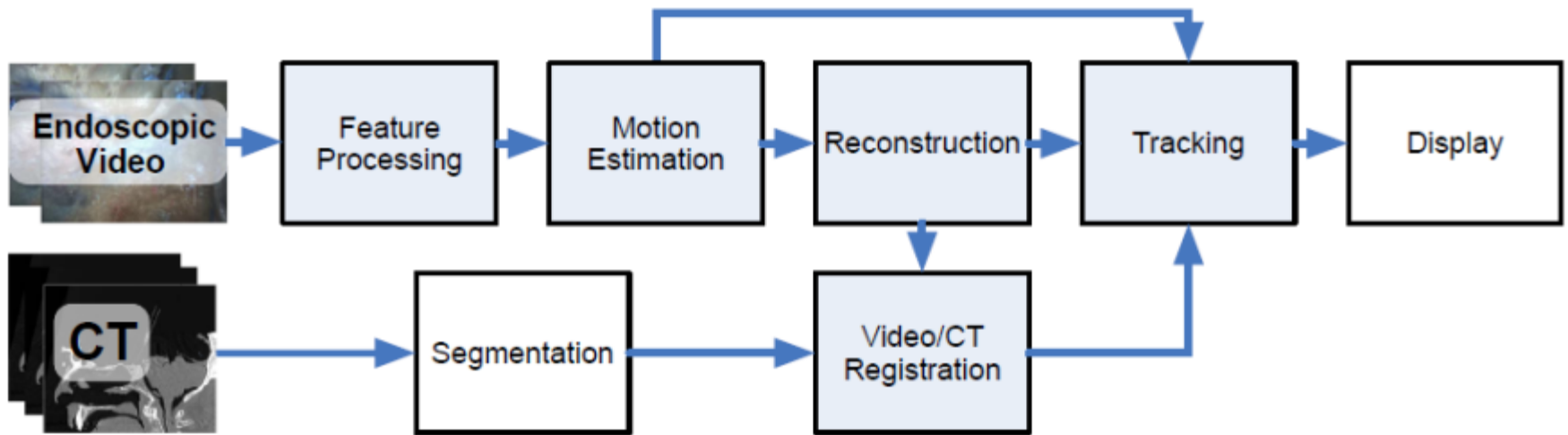

Figure from [*Mirota et al 2012*]

Multi-Affine: basic idea



Figure from [Puerto-Souza *etal* 2011]

MA feature matching

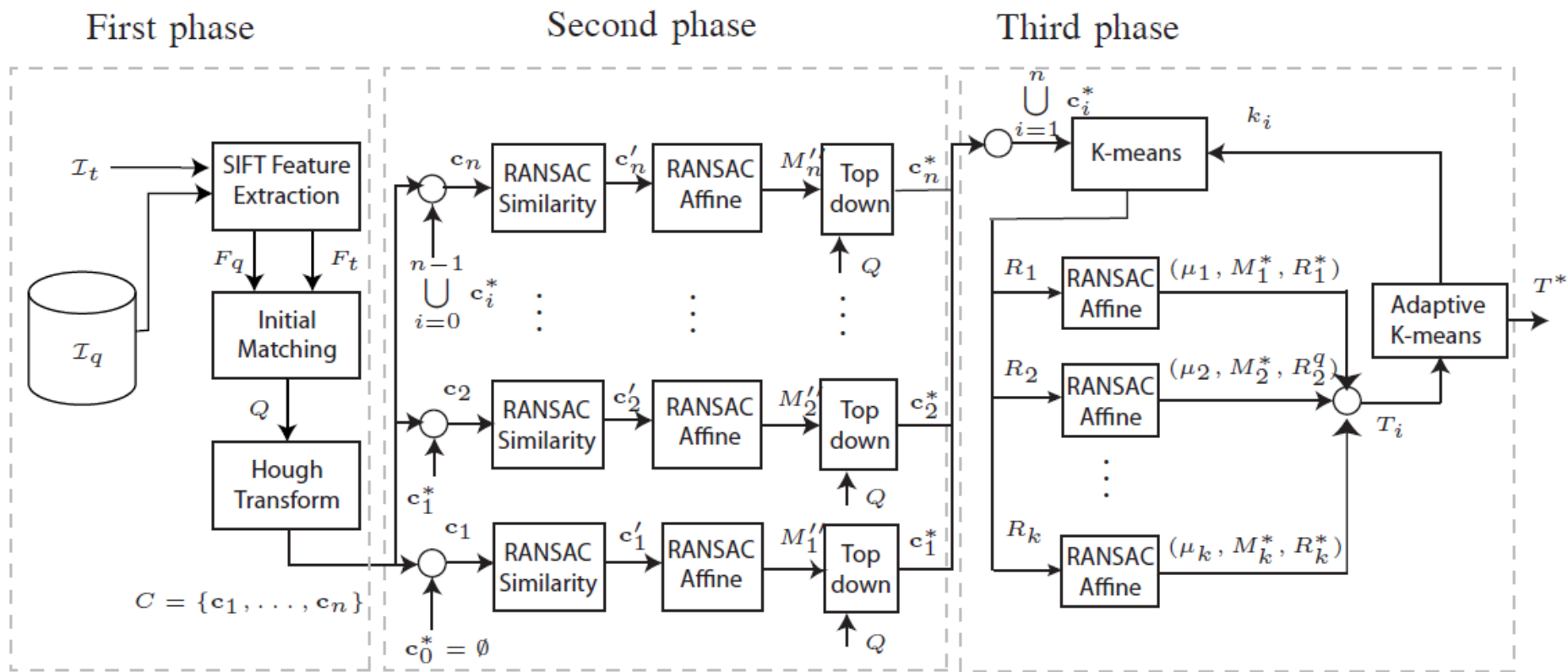

Figure from [Puerto-Souza *et al* 2011]

Hierarchical MA: basic idea

- quantizes matches according to their spatial position on the object's surface

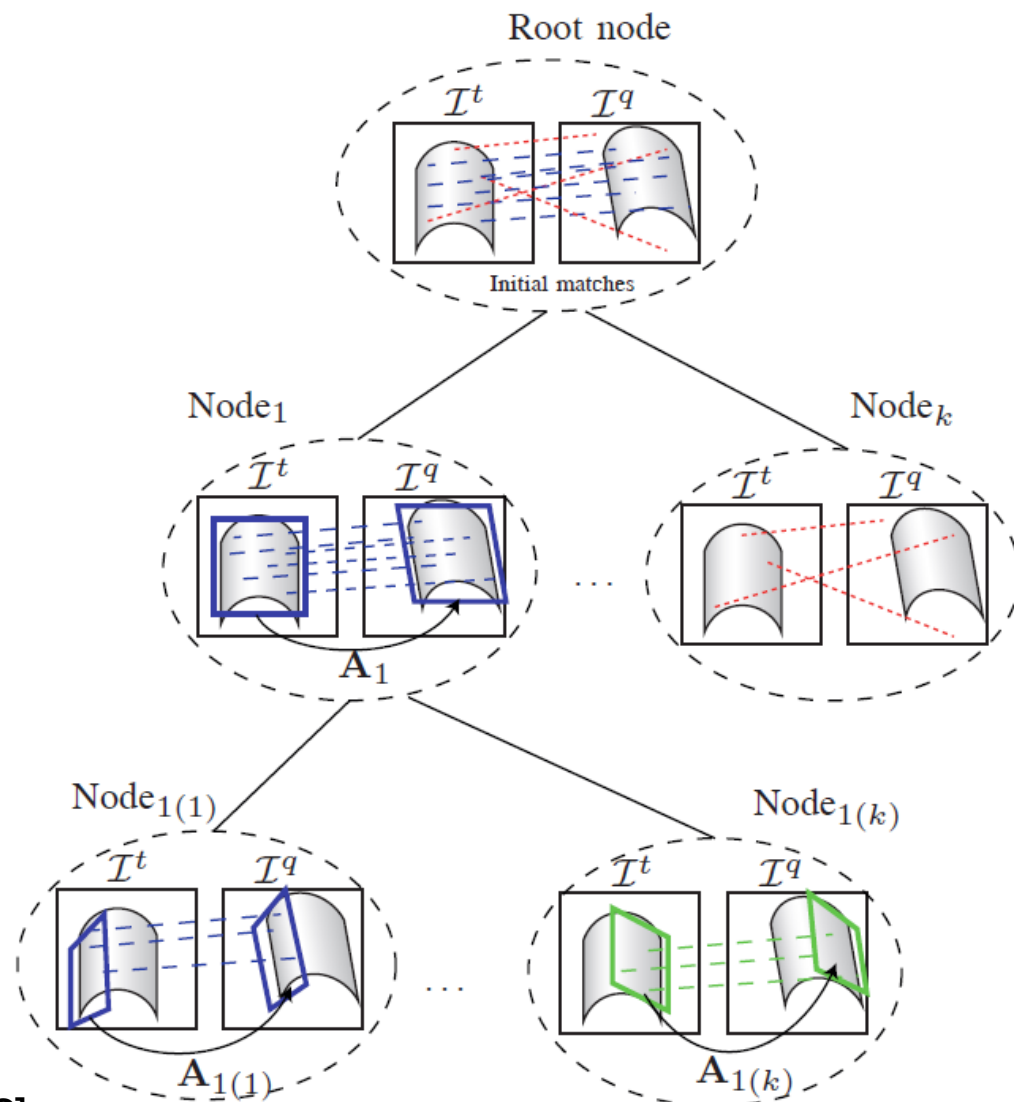

Figure from [Puerto-Souza *et al* 2012]

HMA: speed-up

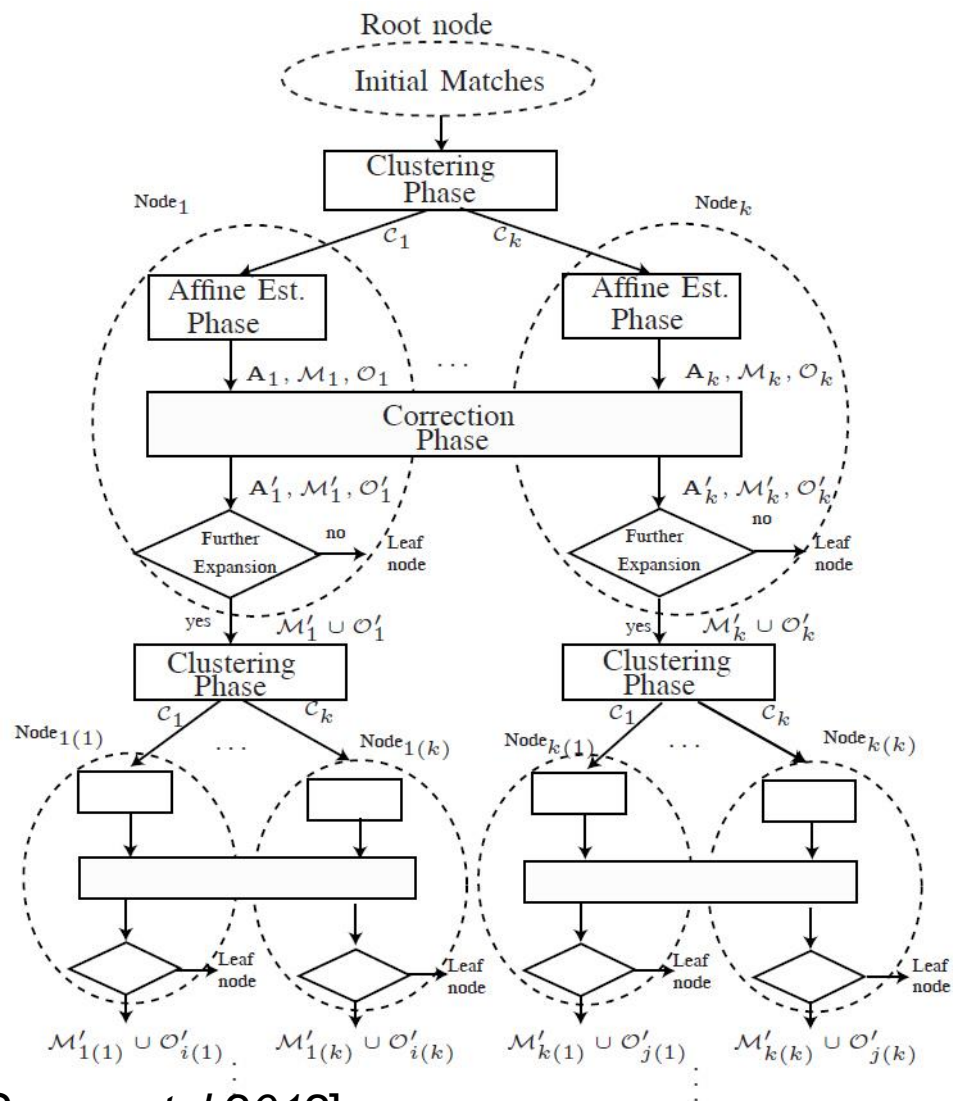

Figure from [Puerto-Souza *et al* 2012]

Progress Summary

Statistics of HMA Feature Matching

Summary on Evaluation

1. Absolute number of outliers: all zero
2. Fraction of inliers out of all matched features: all 100%
3. Evaluating average estimation (projection) error by leaving one out.
4. Evaluating estimation variation in leaving-one-out experiments.

Test sequence

New Sinus R01

Case 12-19-12

Sample video (start): frame 3 - 65 (63 frms)

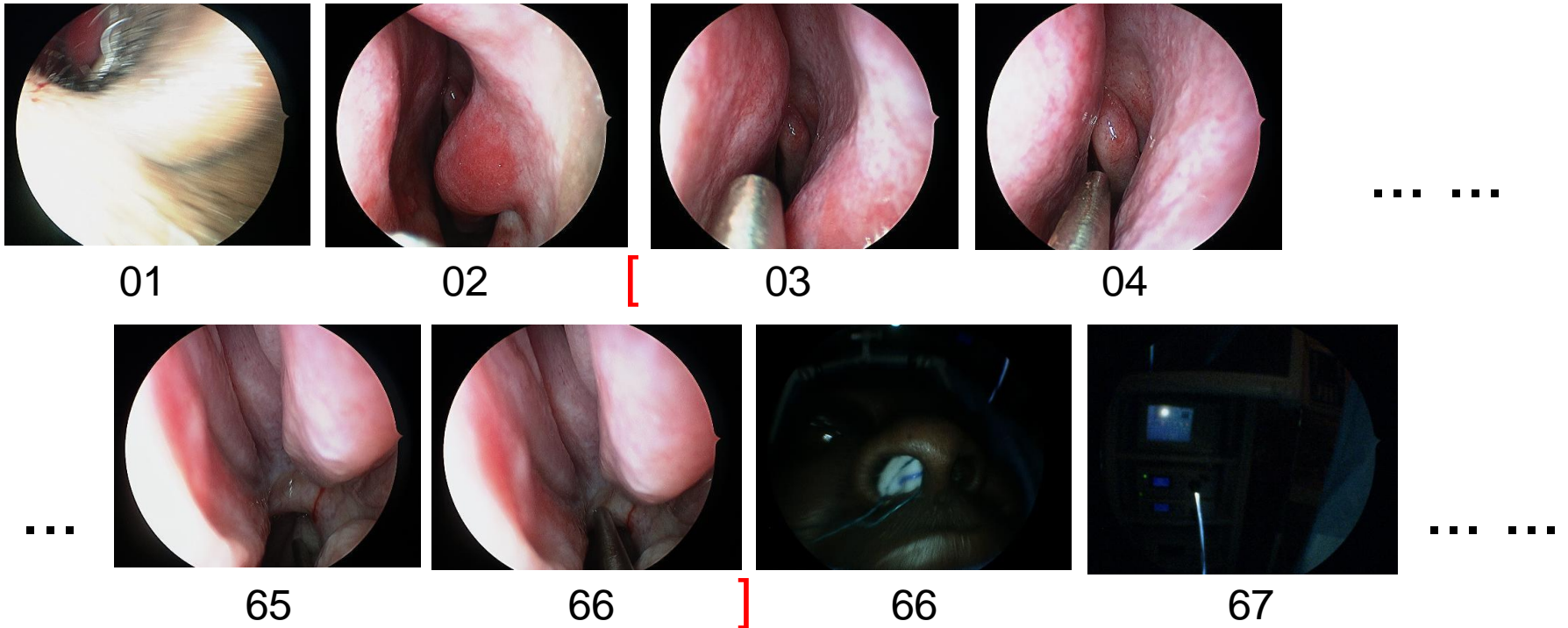

SIFT vs HMA

Some examples

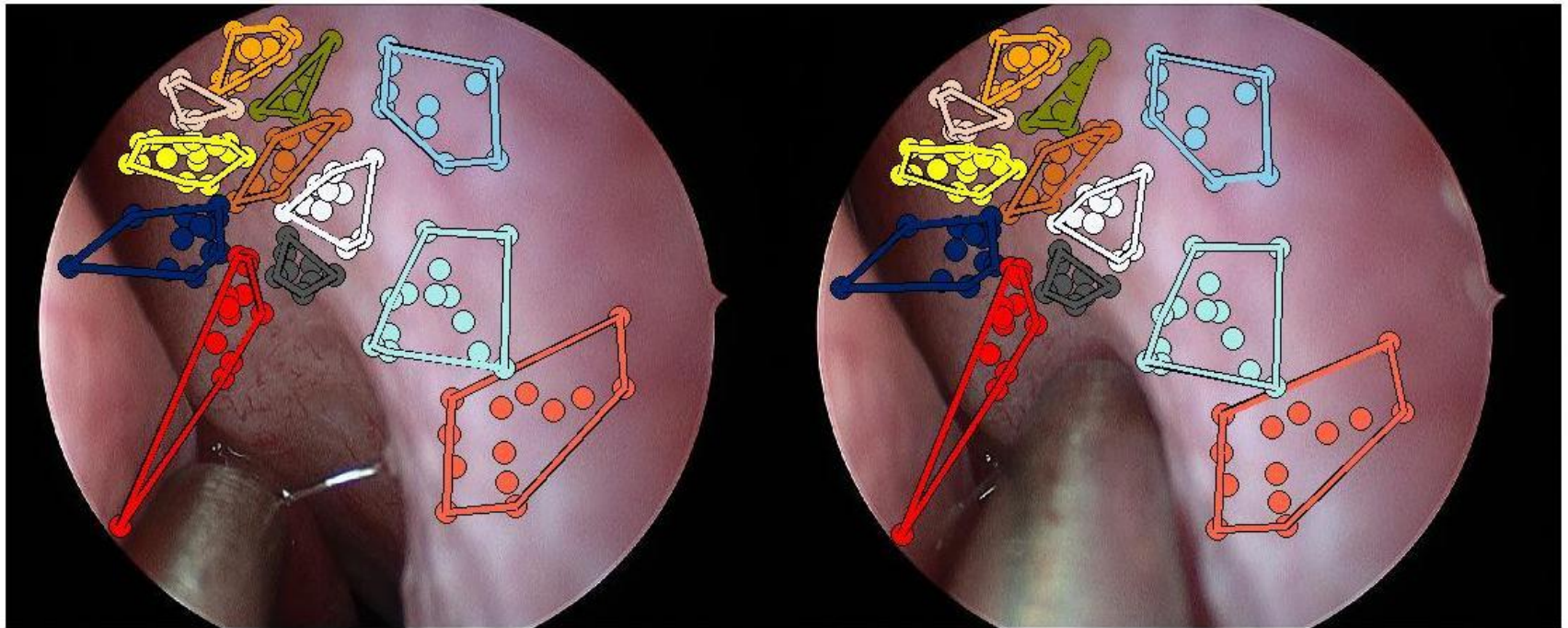
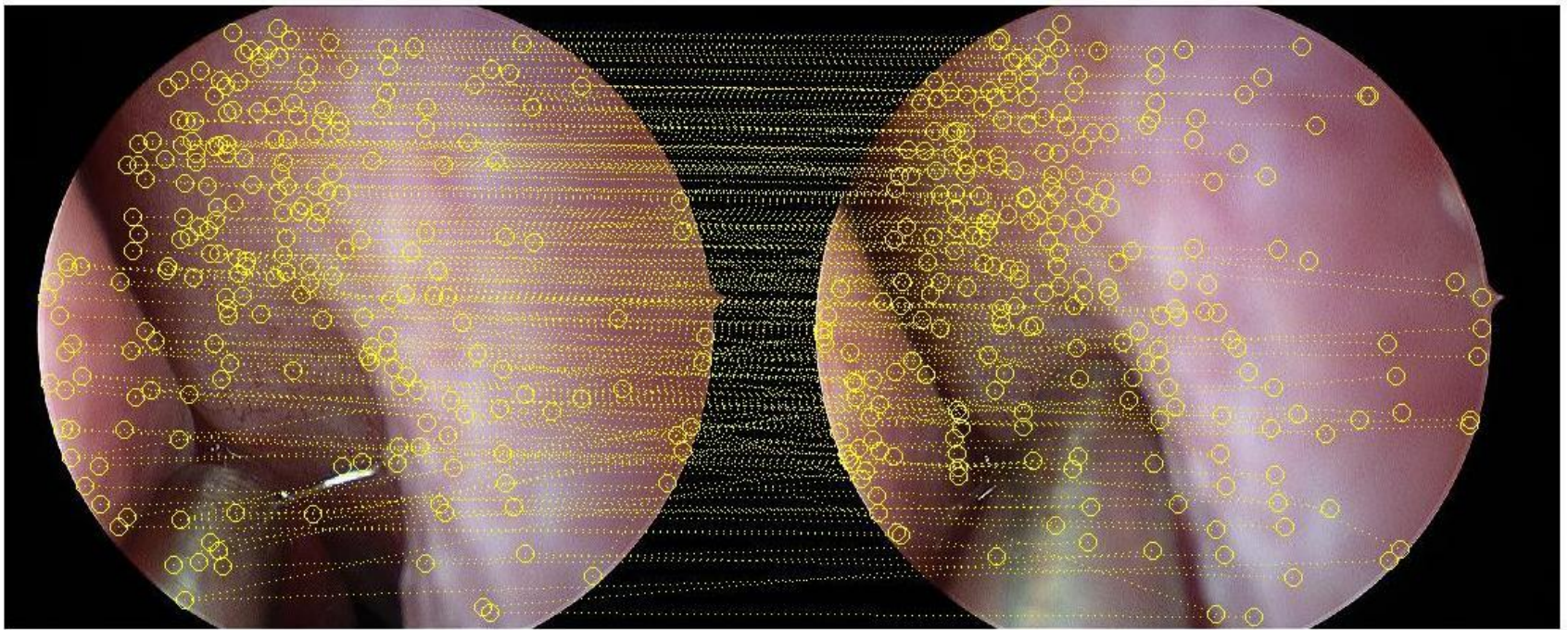

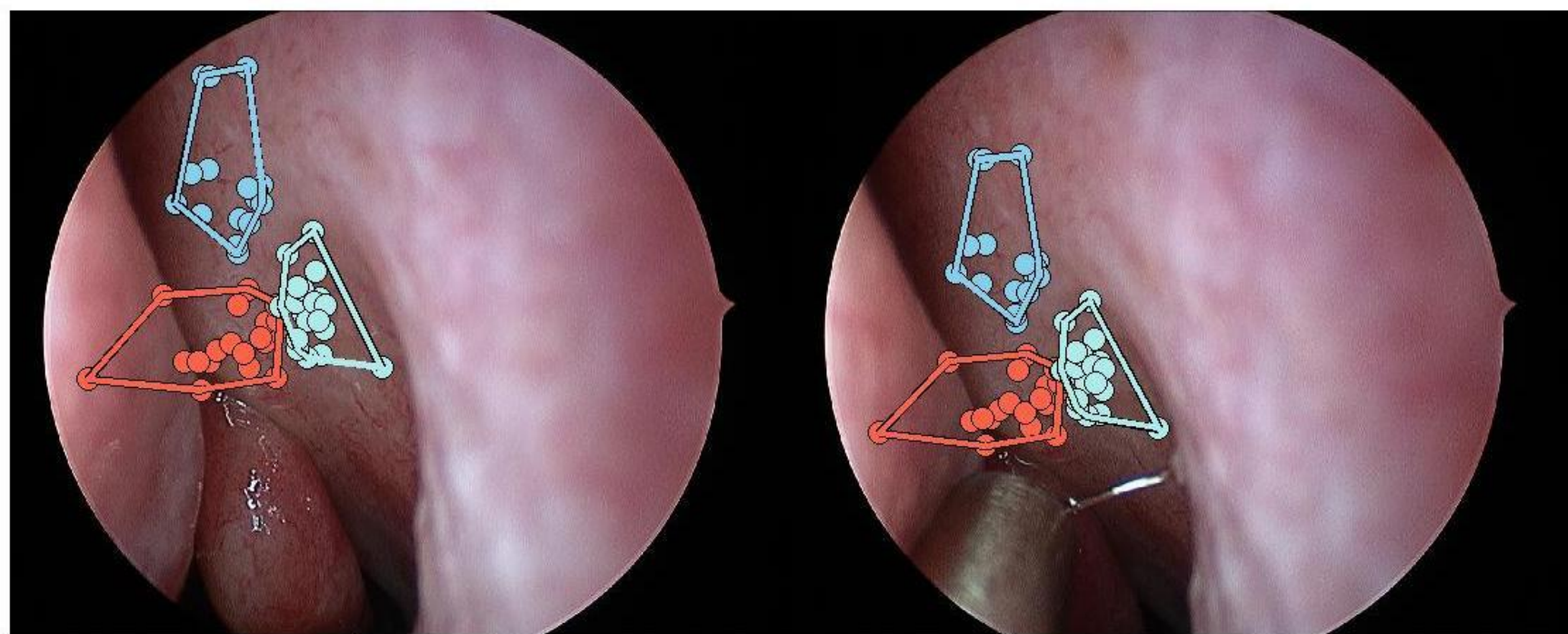
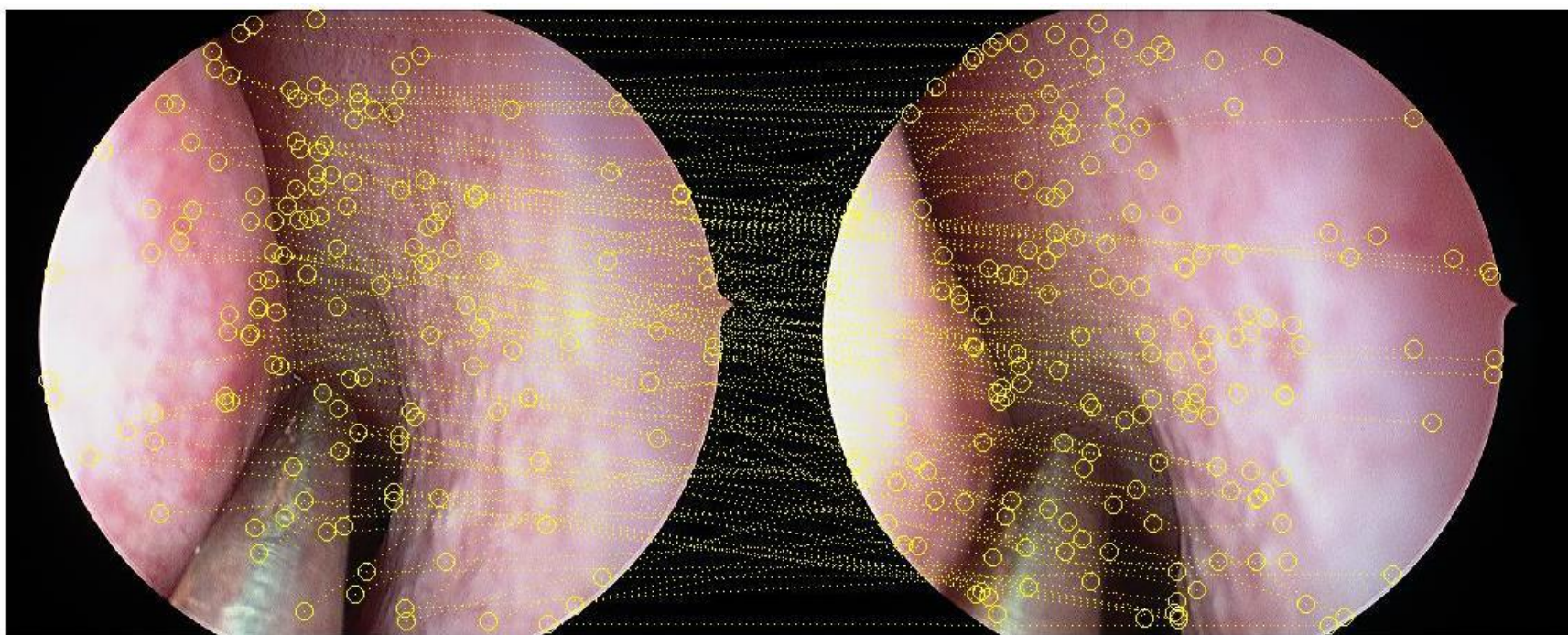

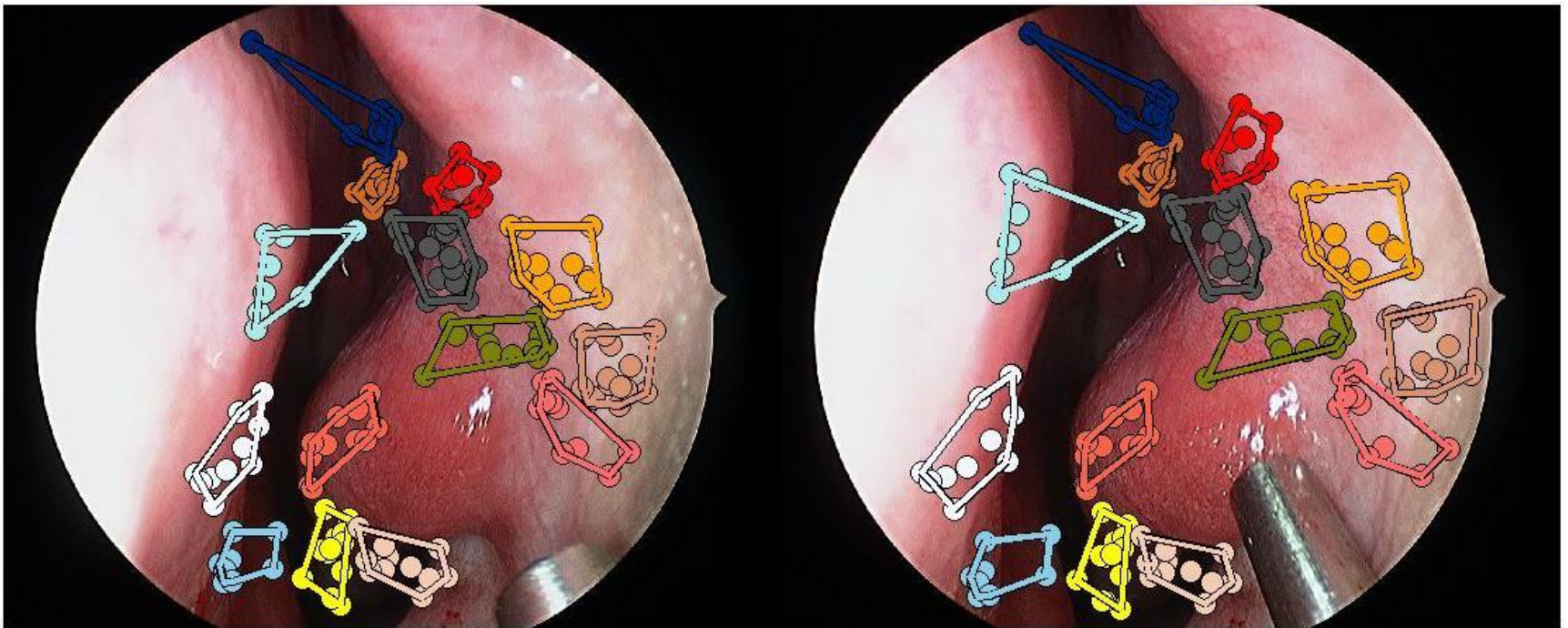
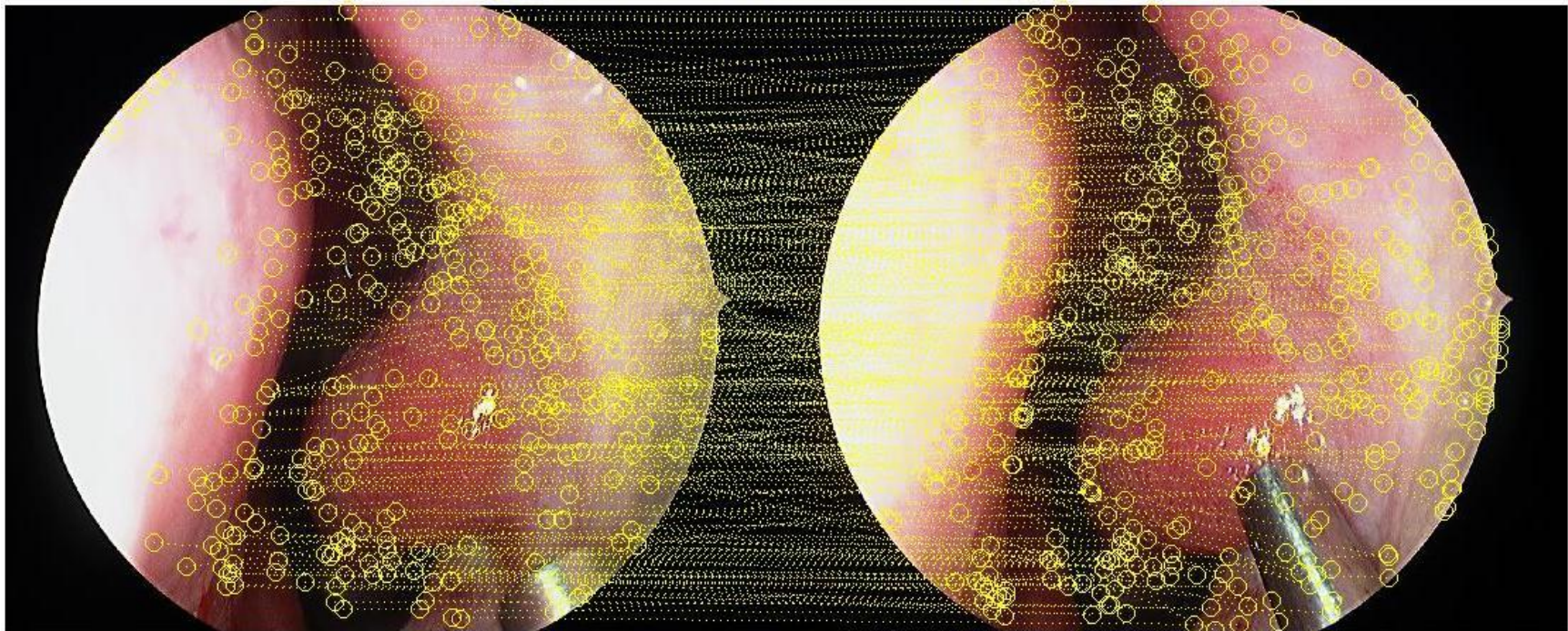

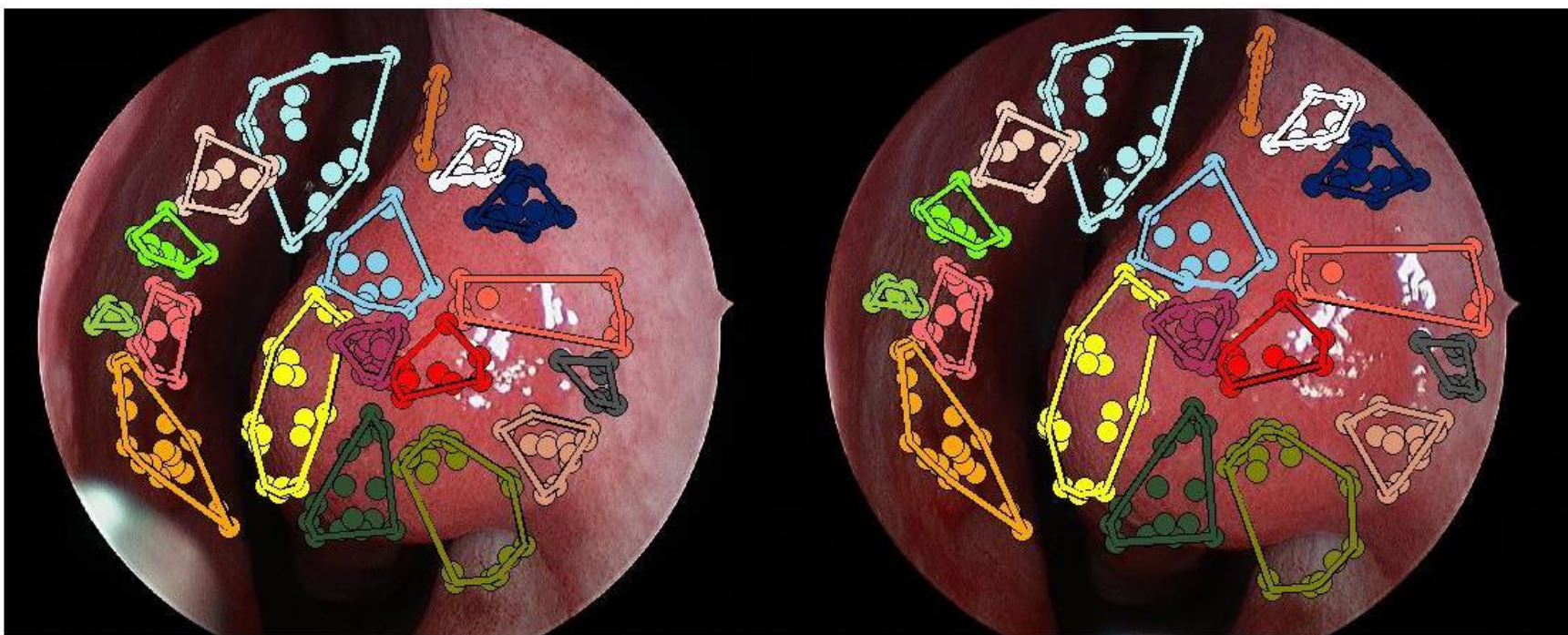
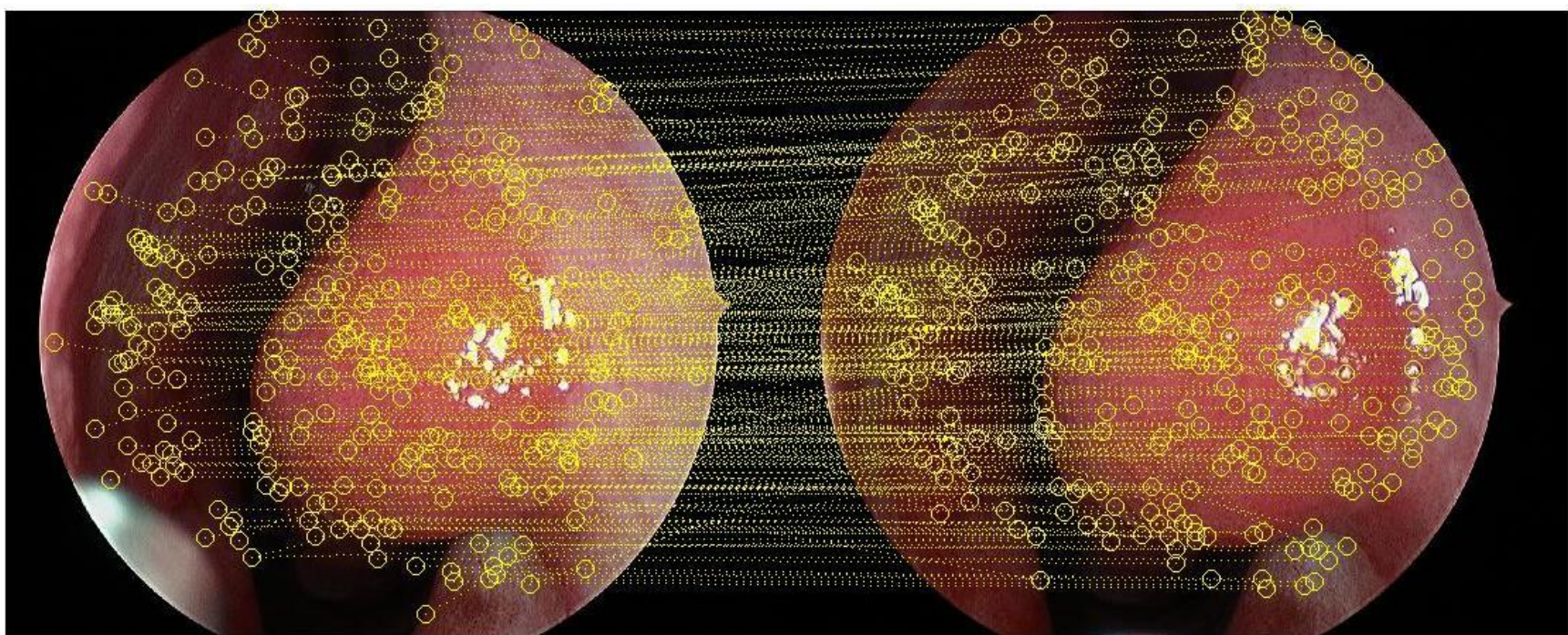

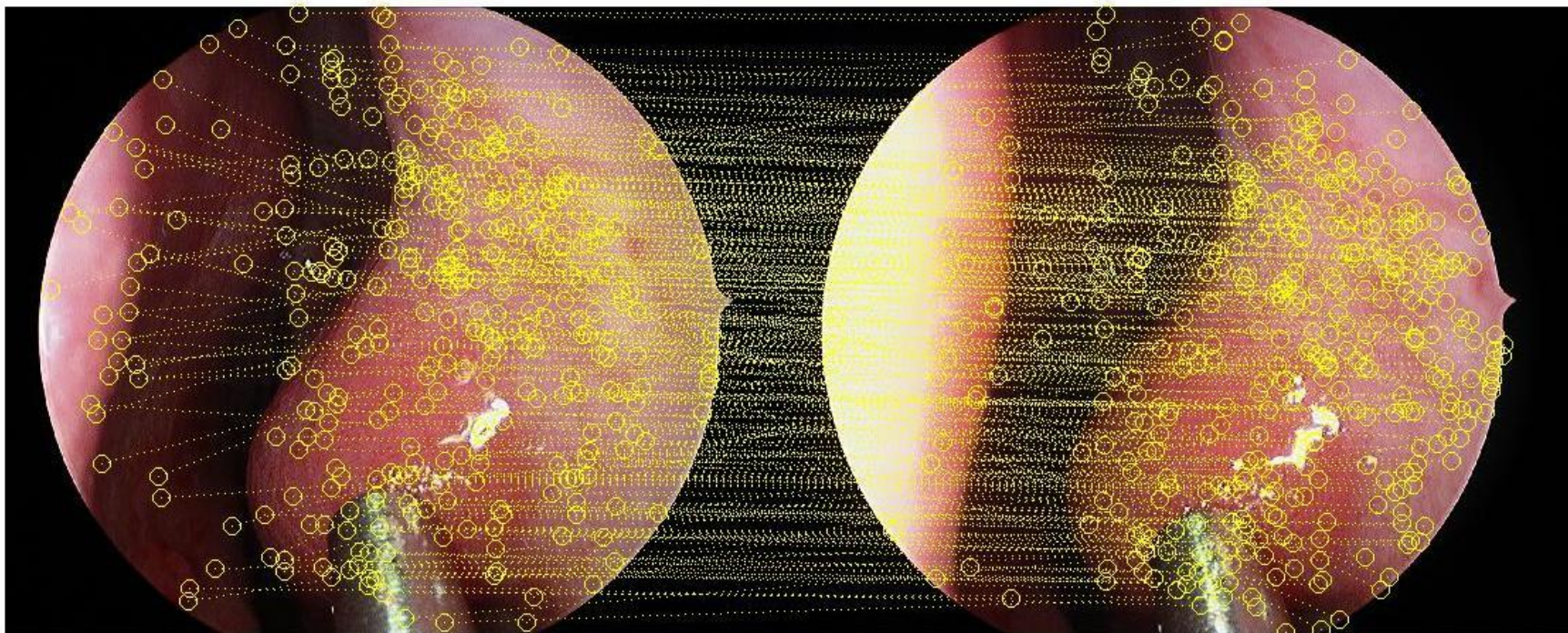

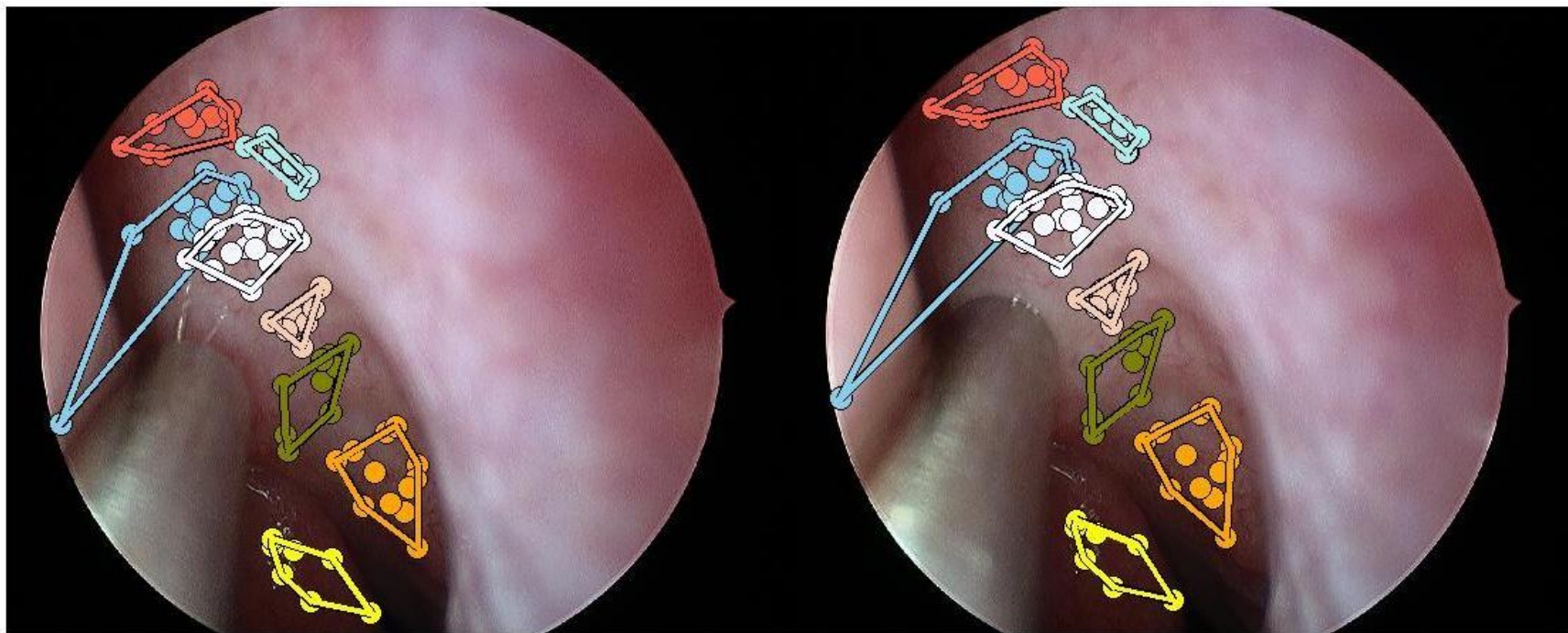
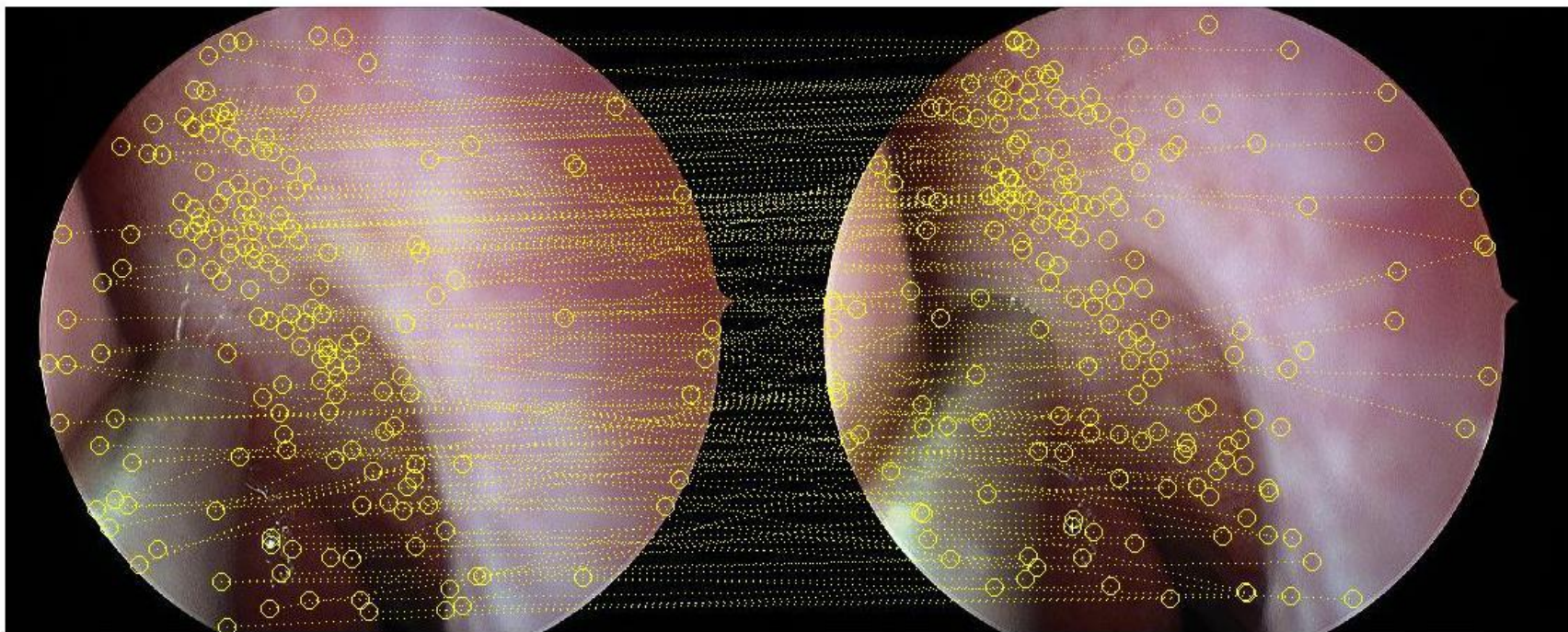

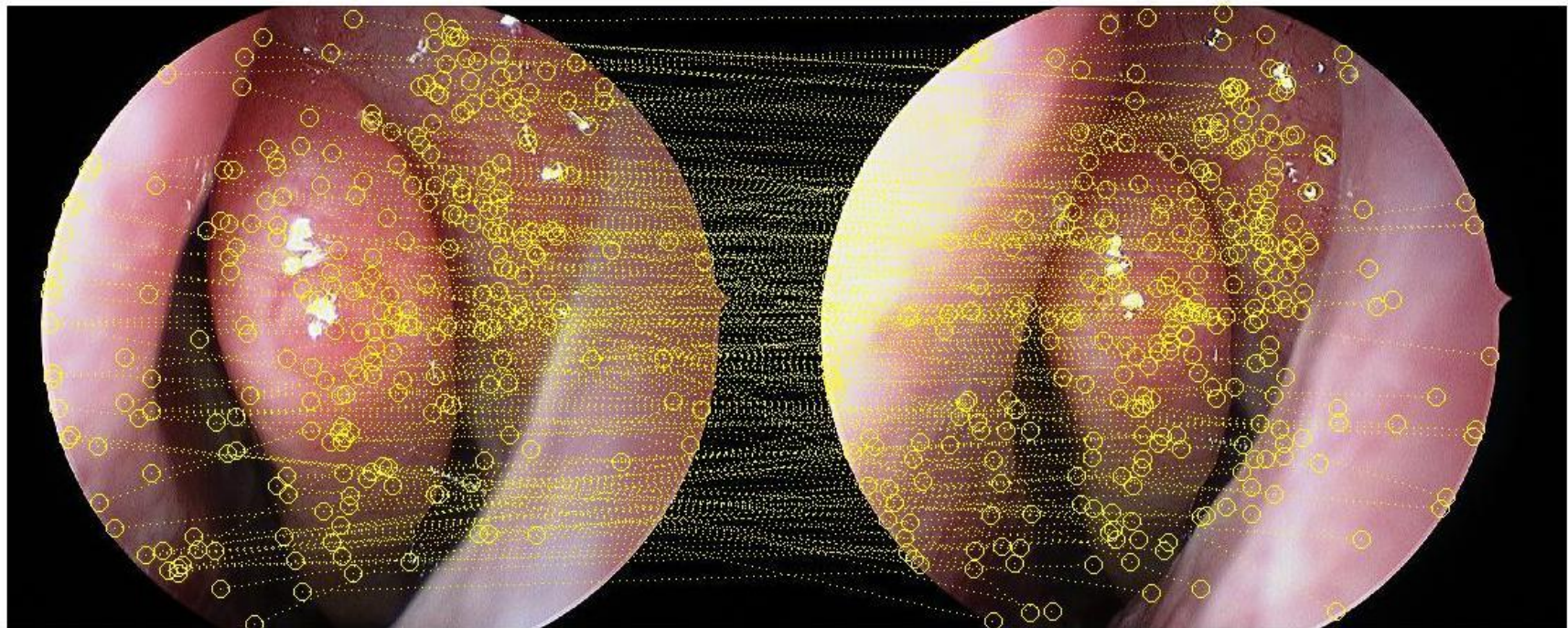

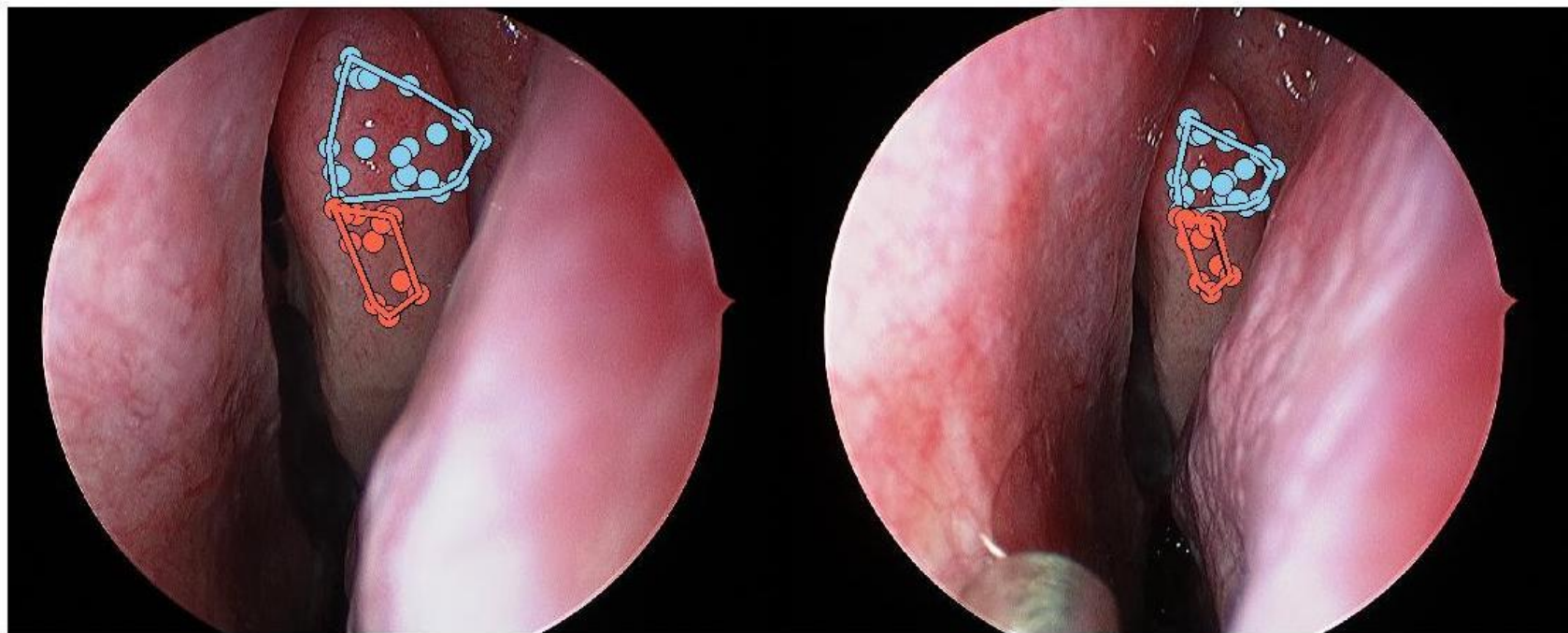
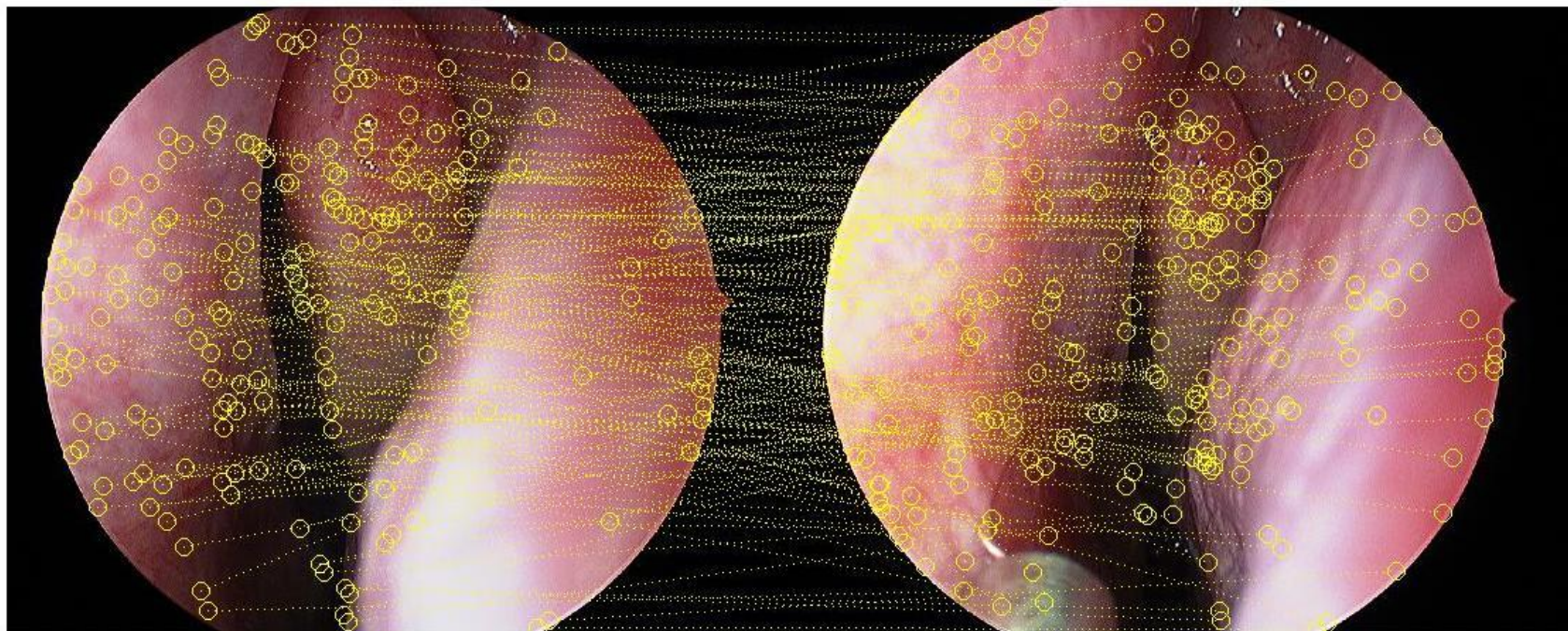

45/63 matched.

Num of matched features

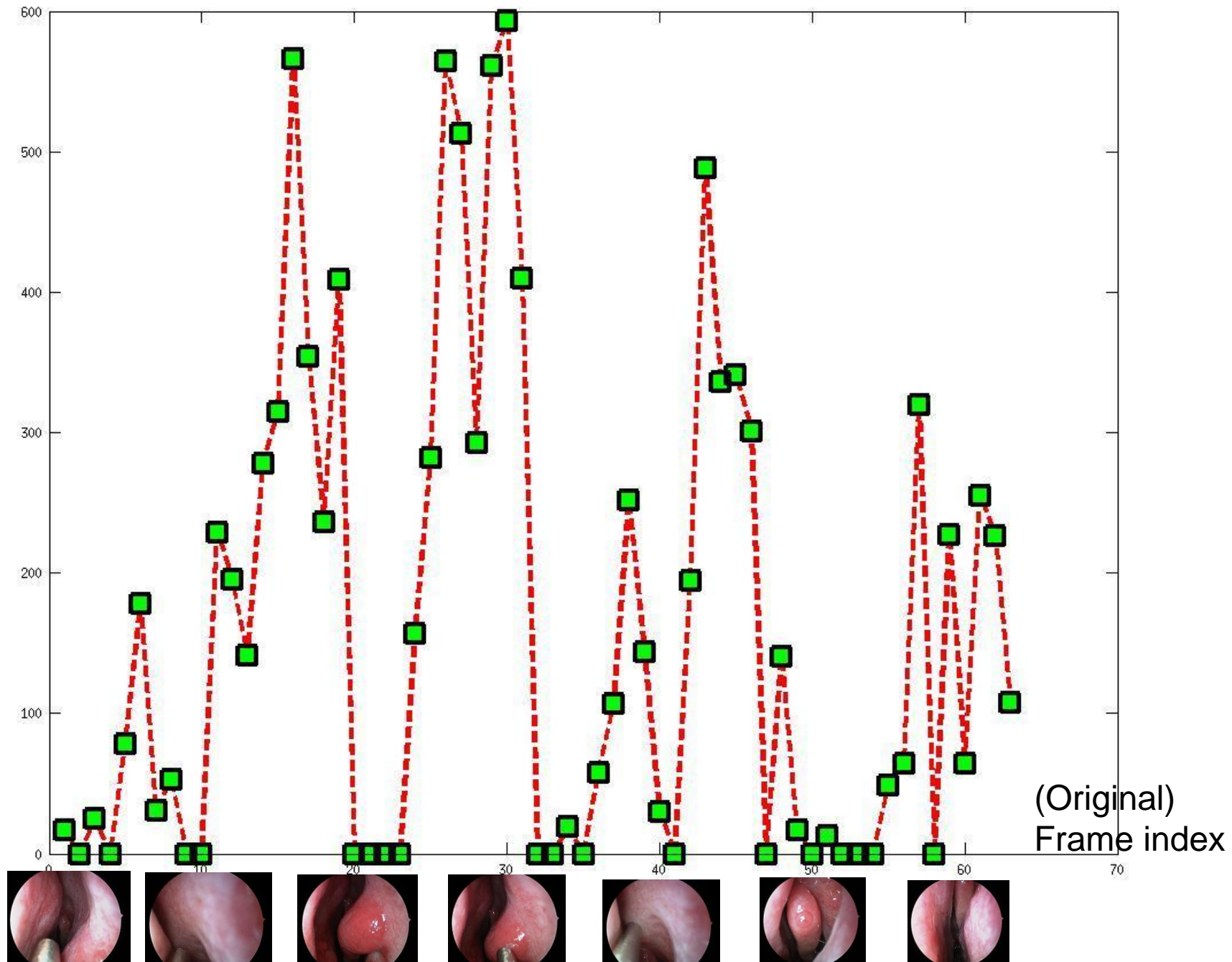

Those frames with zero matched: 04, 06, 11, 12

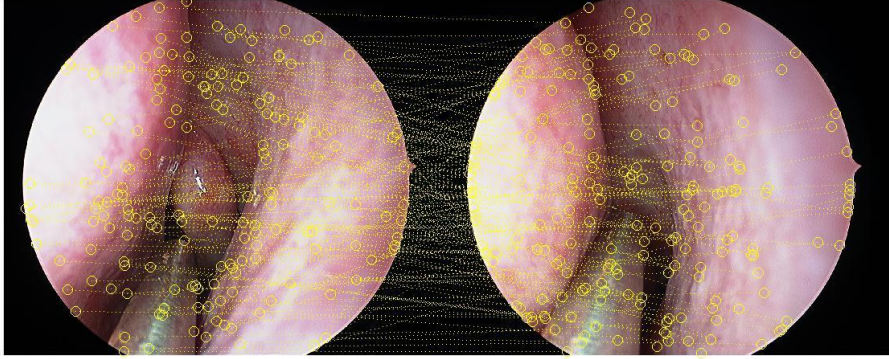

04

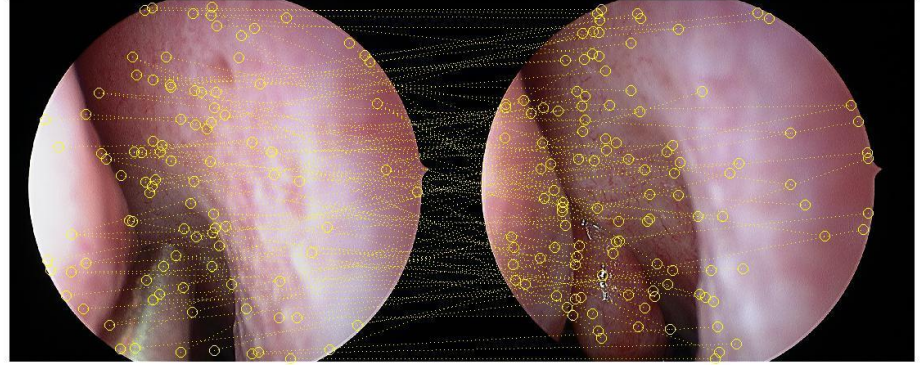

06

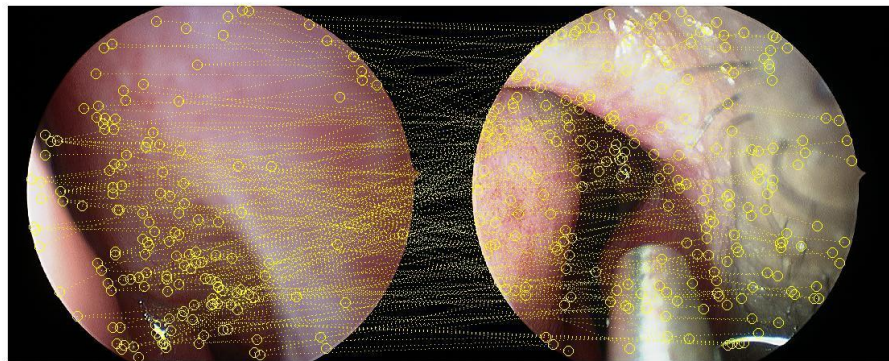

11

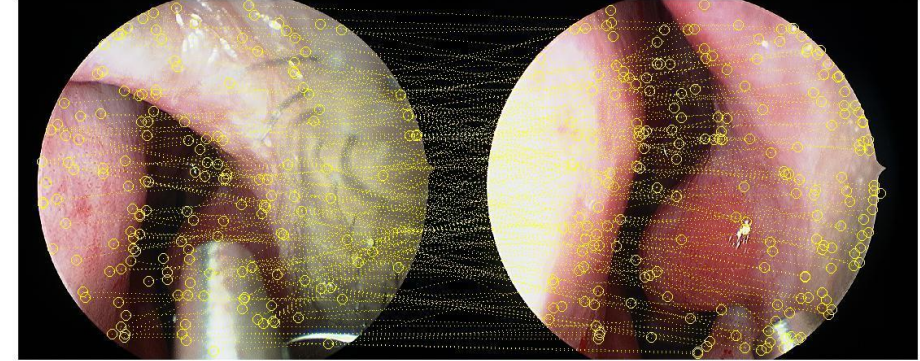

12

Those frames with zero matched: 22, 23, 24, 25

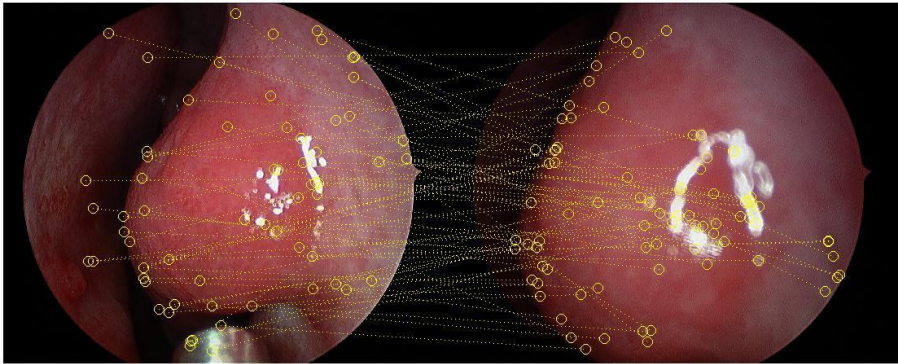

22

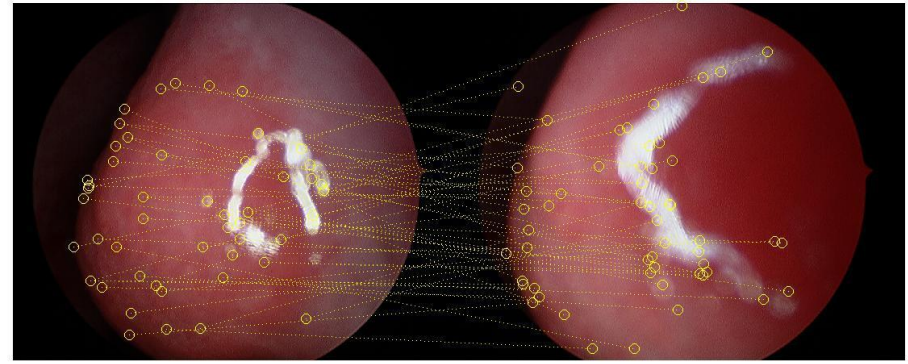

23

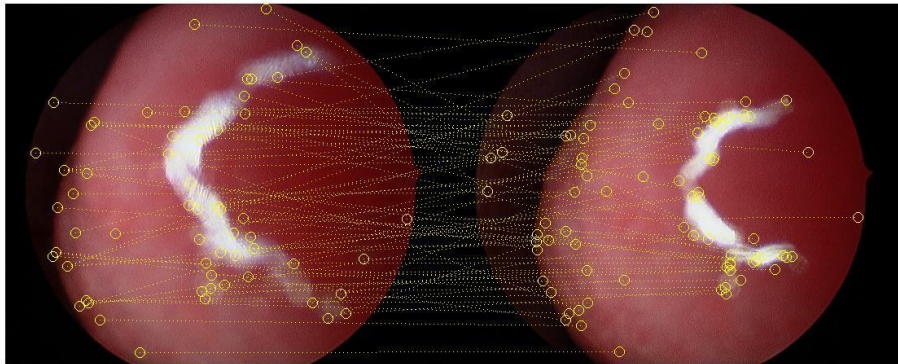

24

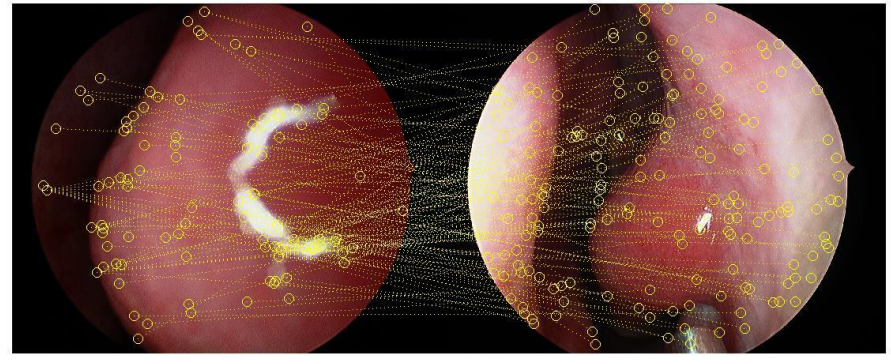

25

Those frames with zero matched: 34, 35, 43, 49

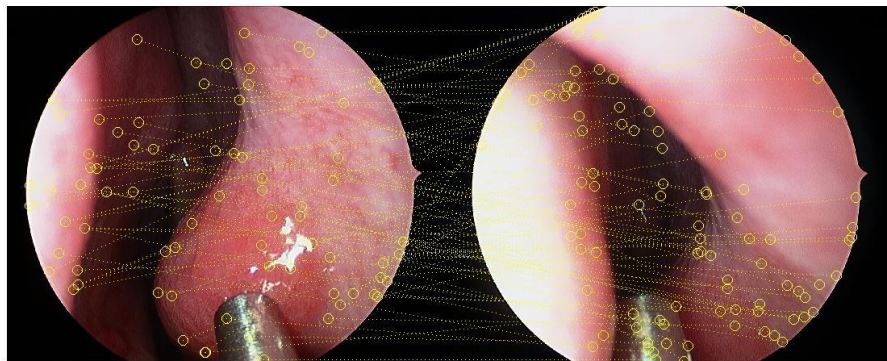

34

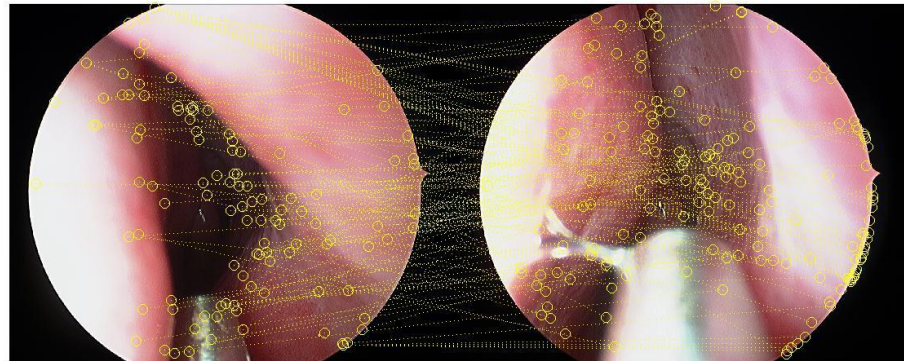

35

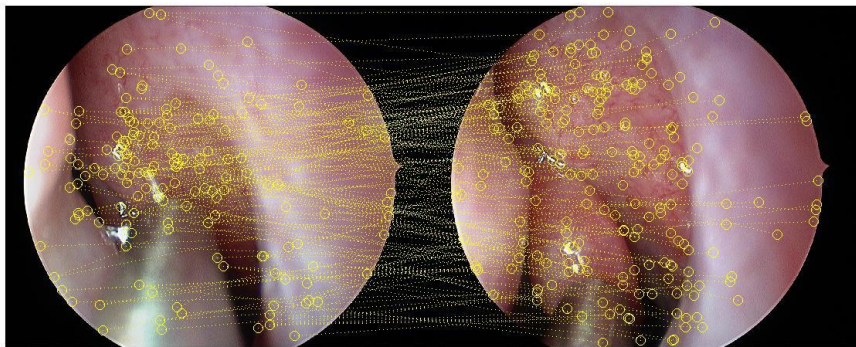

43

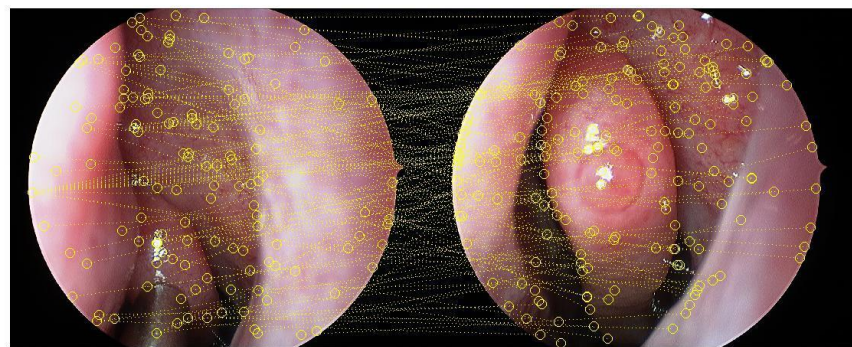

49

Those frames with zero matched features: 52, 54, 55, 56

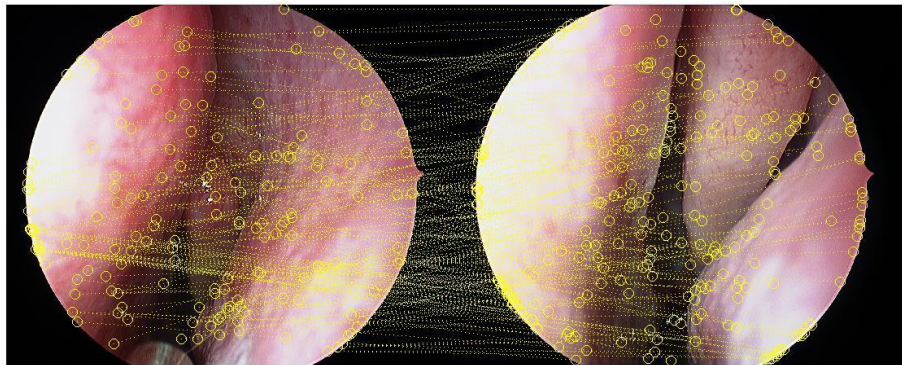

52

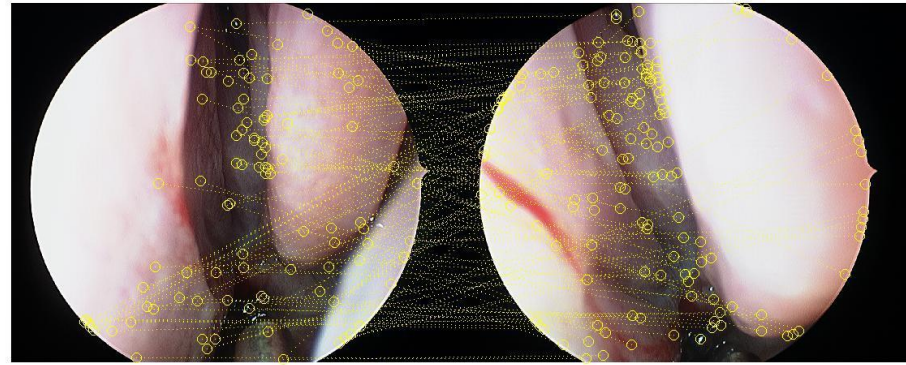

54

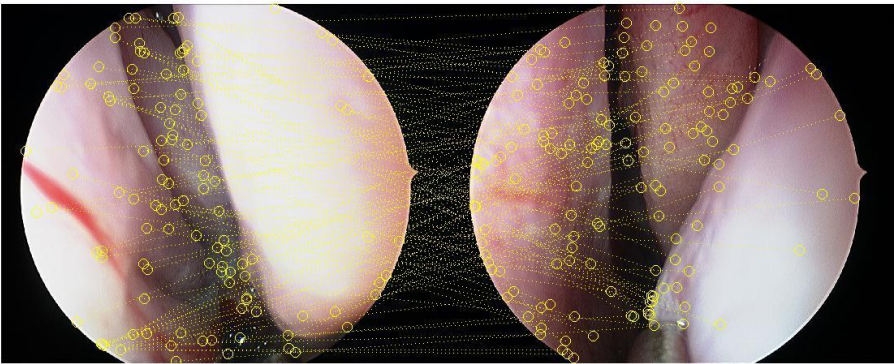

55

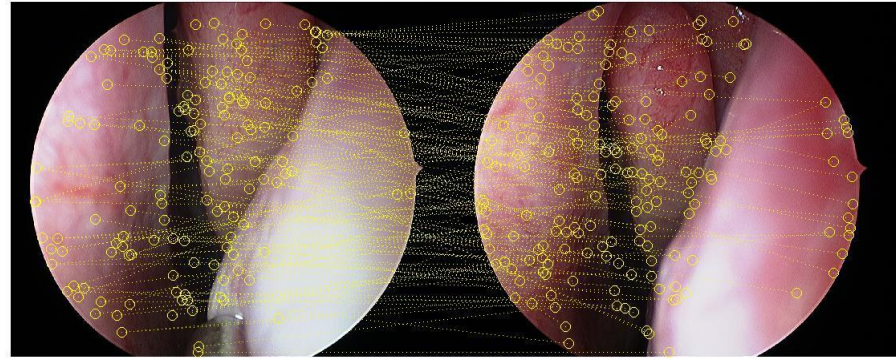

56

HMA

Re-projection (using all matched features)

Mean Square Error of Re-projection (Pixels)

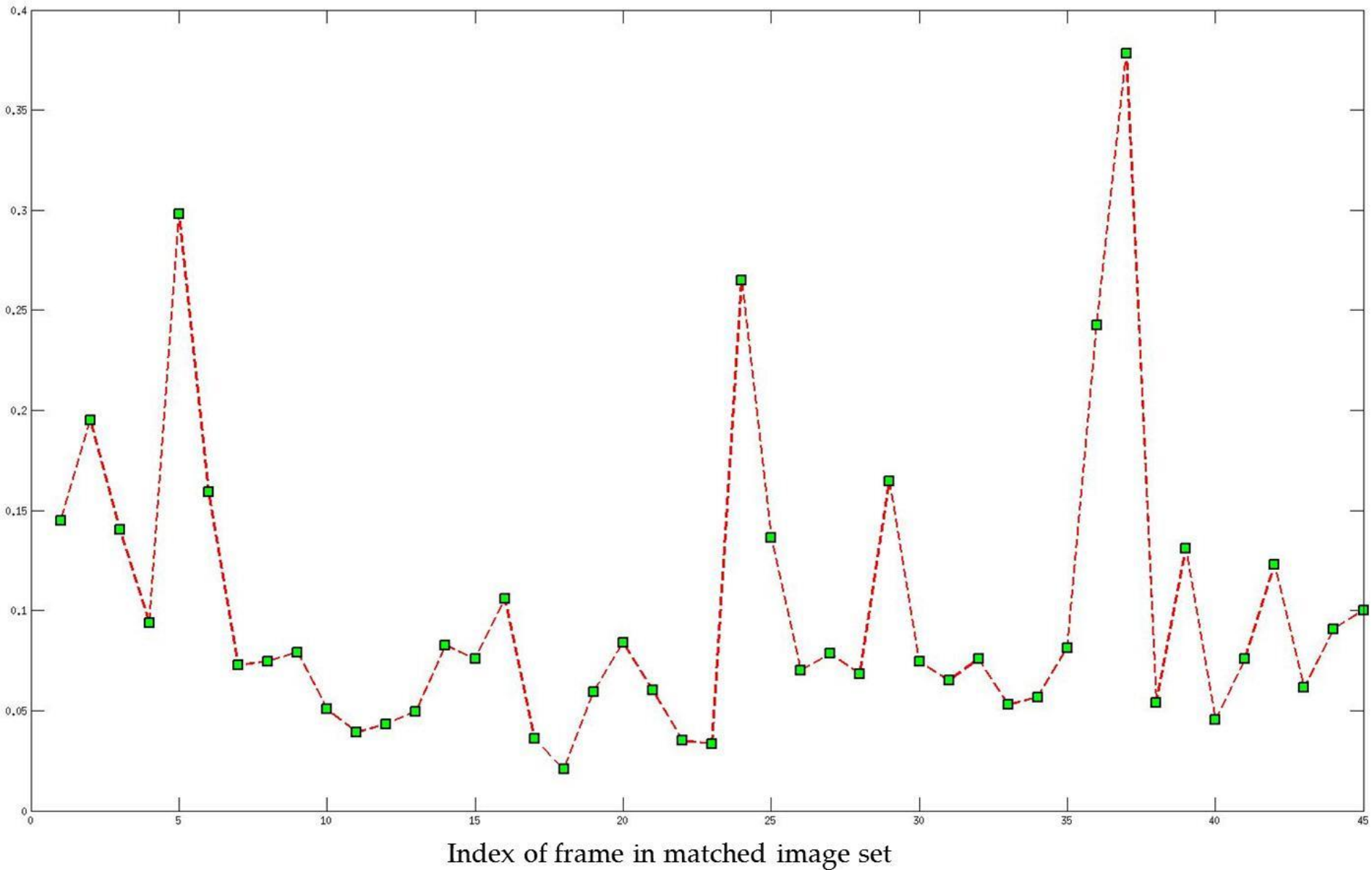

Mean Square Error of Re-projection (Pixels)

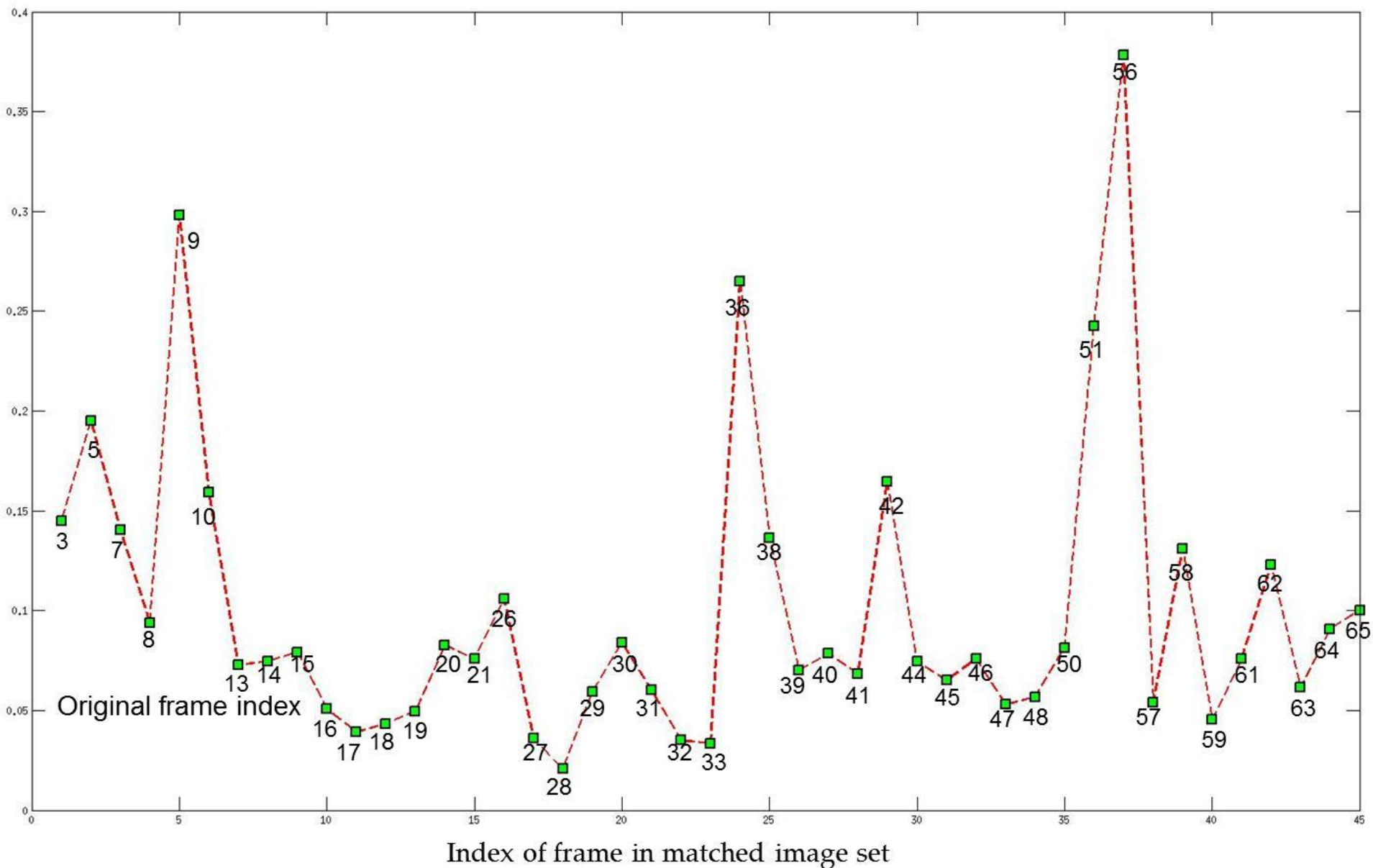

HMA

Leave one out cross validation

Mean Square Error of Testing Projection over All Trials (pixels)

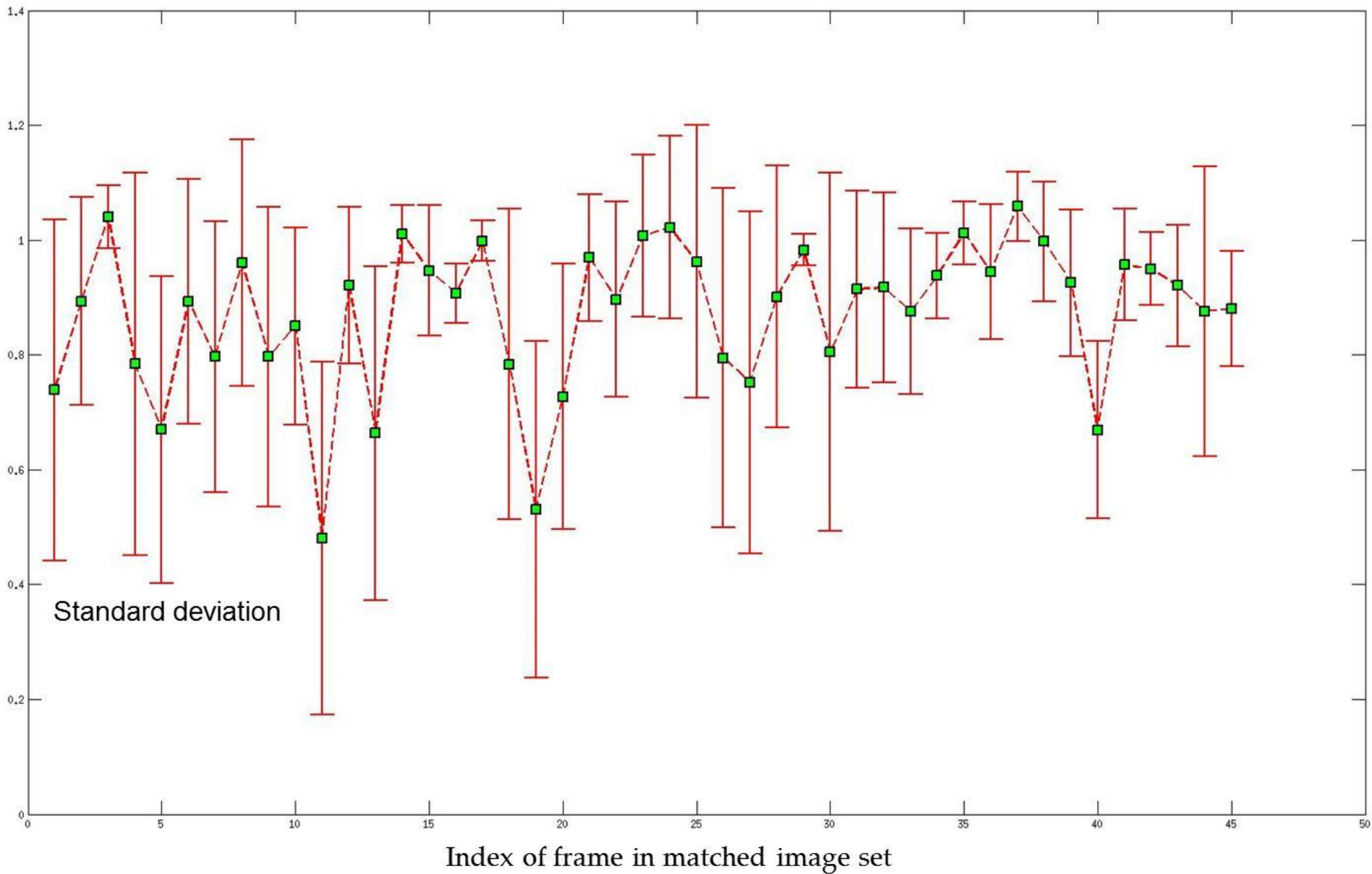

For each matched frame,
 Average projection error of all trials (leaving one out)

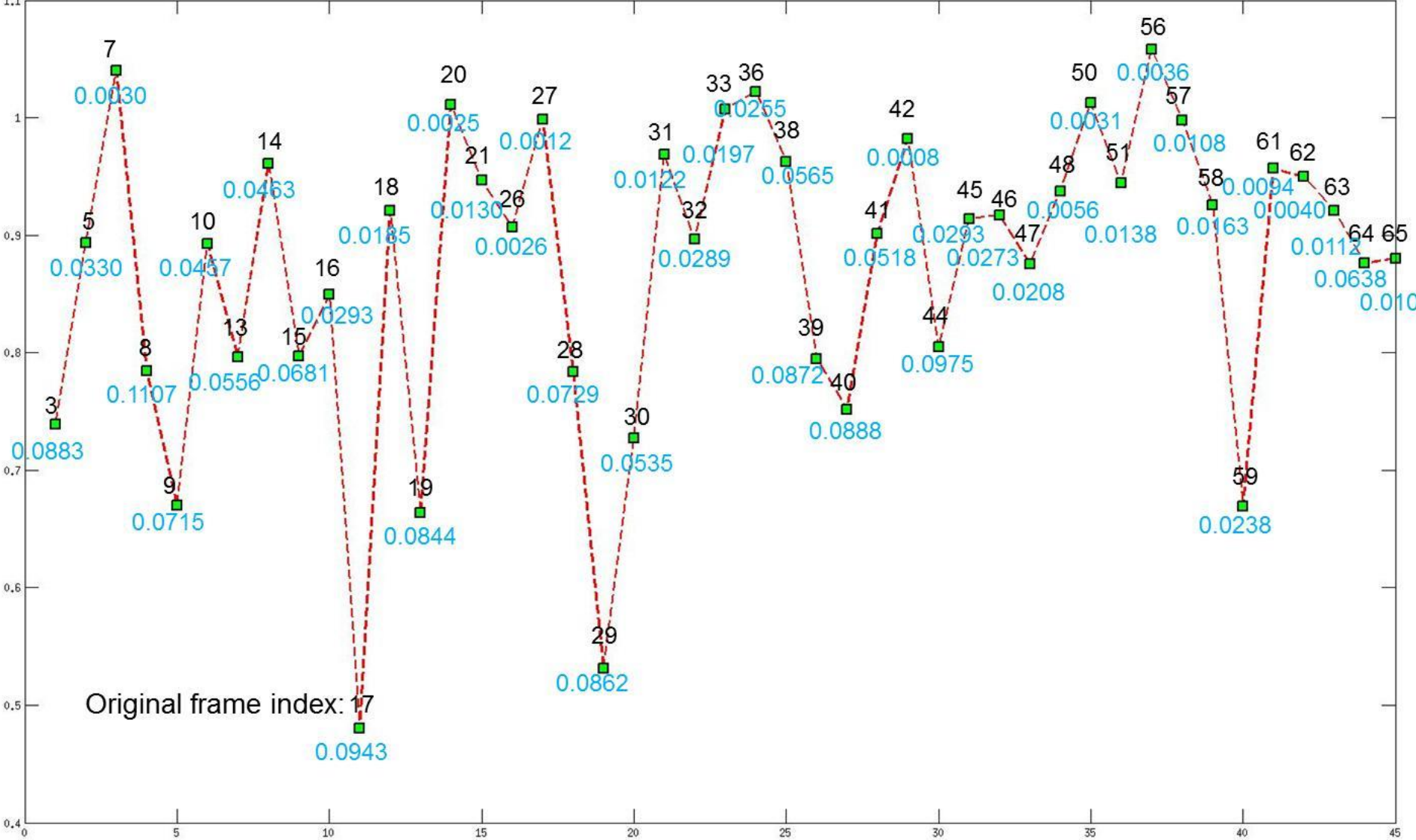

For those frames with matched feaures (matched frames)
 matched frame rate = 45 / 63

By averaging Euler angles

var(:,:,1) represents the mean Rotation matrix from frame 1 to frame 2.

val(:,:,1) =

0.9708	-0.2378	0.0320
0.2360	0.9704	0.0517
-0.0434	-0.0426	0.9982

val(:,:,2) =

0.9910	0.0822	-0.1053
-0.0829	0.9966	-0.0024
0.1048	0.0111	0.9944

val(:,:,3) =

0.9546	0.2096	-0.2119
-0.0351	0.7852	0.6182
0.2960	-0.5827	0.7569

val(:,:,4) =

0.9526	0.2802	0.1183
-0.3039	0.8908	0.3378
-0.0108	-0.3578	0.9338

val(:,:,5) =

0.9644	0.1560	-0.2135
-0.0445	0.8916	0.4506
0.2607	-0.4250	0.8668

val(:,:,6) =

0.9910	-0.1299	0.0307
0.1130	0.9389	0.3252
-0.0711	-0.3188	0.9452

val(:,:,7) =

0.9578	-0.1622	0.2375
0.1840	0.9802	-0.0727
-0.2210	0.1133	0.9687

val(:,:,8) =

0.9646	-0.0431	0.2602
0.1273	0.9402	-0.3161
-0.2310	0.3380	0.9123

val(:,:,9) =

0.9768	-0.1776	0.1194
0.1008	0.8740	0.4754
-0.1888	-0.4523	0.8716

val(:,:,10) =

0.9914	0.0457	0.1229
0.0513	0.7269	-0.6848
-0.1206	0.6852	0.7183

By averaging quaternions (1/2)

Below is the quaternions of the mean estimated rotation matrices from frame 1 to frame 10.

(1) 0.885739549123484 -0.0652796613733813 -
0.0535470809075468 -0.0161692836064051
(2) 0.923701912034307 0.0556356803585799
0.0308665903604673 0.0539772579999490
(3) 0.742119110820174 0.0101463651634439 -
0.00599483205296109 0.0148562878527767
(4) 0.829503117070144 0.000969658804602161
0.00252631839284184 0.00477450725906252
(5) 0.899013301611301 -0.0694260719612894
0.0433862705713932 -0.0532718012963816
(6) 0.905051489884959 -0.0193893297101065 -
0.0223817703024505 0.00926633680852394
(7) 0.874203257665945 -0.0993252150720181 -
0.0790551571477499 0.0903187526419962
(8) 0.887195698007960 -0.0239860333136161
0.0109992162288851 0.0483987876237548
(9) 0.833221816631008 0.00752455831448925 -
0.0435877421590169 0.00838672772523419
(10) 0.898001642695069 0.00282697375996572 -
0.0116902091024734 0.000763433972699625

By averaging quaternions (2/2)

val(:,1) =

0.9921	-0.0273	0.1224
0.0450	0.9886	-0.1438
-0.1171	0.1482	0.9820

val(:,2) =

0.9910	0.1199	-0.0593
-0.1119	0.9860	0.1234
0.0733	-0.1156	0.9906

val(:,3) =

0.9991	0.0398	0.0167
-0.0402	0.9988	0.0270
-0.0156	-0.0276	0.9995

val(:,4) =

0.9999	0.0115	-0.0061
-0.0115	0.9999	0.0024
0.0061	-0.0023	1.0000

Updated Milestones

- Milestone 1: Program for robust feature matching by HMA algorithm.
 - Planned Date: 28th February. Expected Date: 7nd March
- Milestone 2: Program for motion estimation by RANSAC and 5 point algorithm.
 - Planned Date: 14th March. Expected Date: 14th March
- Milestone 3: Program for video-CT registration by Trimmed ICP algorithm
 - Planned Date: 21st March. Expected Date: 28th March
- Milestone 4: Program for 3D reconstruction
 - Planned Date: 14th April. Expected Date: 21th April
- Milestone 5: Experiments for the holistic pipeline
 - Planned Date: 7th May. Expected Date: 9th May

Reference

- D. Mirotu, H. Wang, R. H. Taylor, M. Ishii, G. L. Gallia and G. D. Hager. A System for Video-Based Navigation for Endoscopic Endonasal Skull Base Surgery. IEEE Trans. Med. Imaging, 31(4), 963-976, 2012.
- G. Puerto, M. Adibi, J. Cadeddu and G. L. Mariottini, Adaptive Multi-Affine (AMA) Feature-Matching Algorithm and its Application to Minimally-Invasive Surgery Images. IEEE/RSJ International Conference on Intelligent Robots and Systems (IROS), pp. 2371 - 2376, Sept. 25-30, San Francisco, California, 2011.
- G. A. Puerto-Souza and G. L. Mariottini. Hierarchical Multi-Affine (HMA) algorithm for fast and accurate feature matching in minimally-invasive surgical images. 2012 IEEE/RSJ International Conference on Intelligent Robots and Systems October 7-12, 2012. Vilamoura, Algarve, Portugal.
- D. Chetverikov , D. Svirko , D. Stepanov and Pavel Krsek. The Trimmed Iterative Closest Point Algorithm, ICPR, 2002.

Thank you! Comments!

Lesson's Learned for Presentation

- Be prepared.
- Never hurt to remind the audiences background materials. Consider variety of audiences.