

Position Control of BIGSS Lab Snake for Revision Total Hip Arthroplasty (THA) Surgery

600.446 Computer Integrated Surgery II

Final Report



Project 6:

Farshid Alambeigi

Mentors:

Dr. Mehran Armand, Ryan Murphy, Dr. Russell Taylor

Spring 2014

Abstract:

The BIGSS Lab is developing a minimally-invasive surgical workstation to treat the osteolysis behind the well-fixed cup during revision surgery. They have developed a Dexterous Snake-like Manipulator (SDM) for this purpose. This dexterous manipulator will be an active cannulae for guiding tools in a surgical workstation for the diagnosis, planning and real-time intra-operative treatment of the lesions. In the envisioned application, the SDM will be positioned in the workspace by a robotic arm with at least six degrees of freedom (DoF) and uses screw holes in the acetabular implant as its entry to the patient's body. This project focuses on interfacing the SDM with a 6 DOF Universal Robot (UR5) and position control of SDM inside the lesion.

First part of this project, addresses the coupled motion of a 6 degrees of freedom robot and the mentioned SDM. We have formulated the problem as a weighted, multi-objective constraint, linear optimization. A Remote Center of Motion (RCM) has been considered as a virtual constraint for the robot. We have evaluated our method by simulating the coupled system inside a potential lesion area. Second part of this work is related to design and fabrication of a interfacing part for attachment of SDM to UR5 robot.

Introduction:

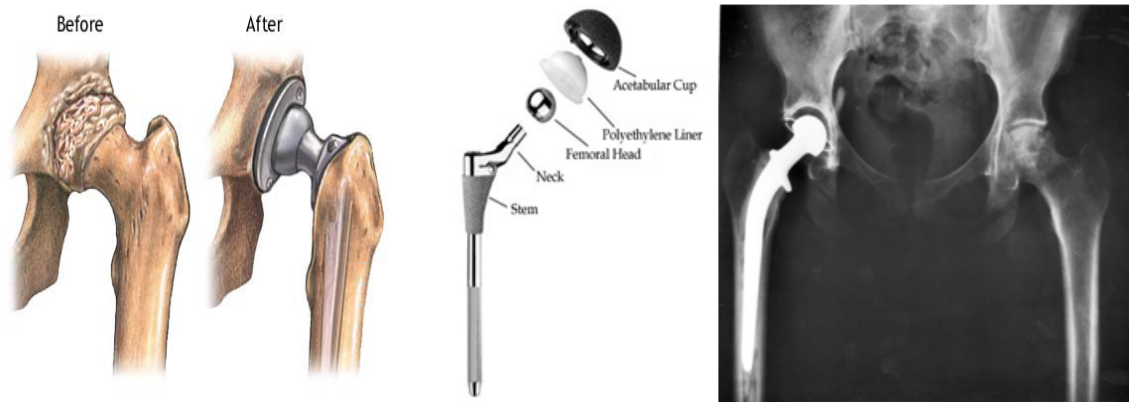

Figure 1. Basic principle of total hip arthroplasty(THA) surgery.

Wear of the articulating components (Figure 2.a) in a total hip arthroplasty (THA) surgery (Figure 1), typically a polyethylene liner, leads to formation of polyethylene particles that cause macrophage activation and osteolysis of the bone surrounding the implant (Figure 2.b). According to Figure 2.c, if this procedure left unmonitored and untreated eventually fracture and component loosening with catastrophic failure will occur. Diagnosis and treatment of pelvic osteolysis is both challenging and complex, with multiple decision points depending on the extent of lesions and the degree to which the implant is well-fixed. The current less-invasive treatments have been shown to reliably fill less than half of the osteolytic defects behind the acetabular cup (Figure 2.b). Current manual tools are hard to manipulate precisely, and lack sufficient dexterity to permit surgeons reach all the lesion area. This clinical problem motivated the development of a novel system for this kind of surgeries.

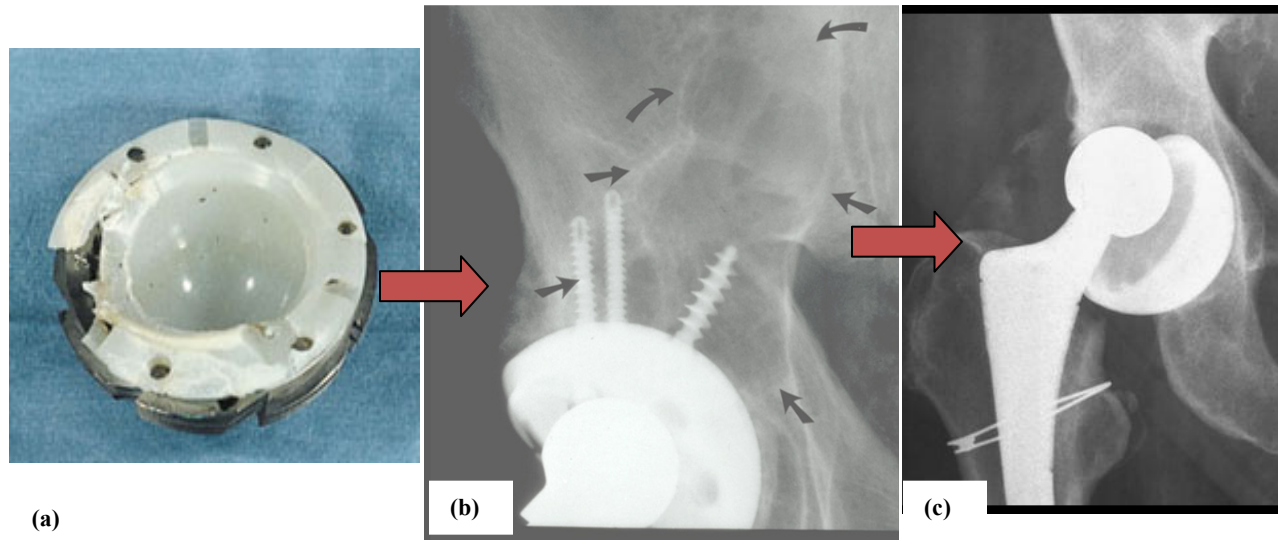

Figure 2. (a)Wear of polyethylene liner in acetabular cup, (b)Osteolysis,(c) failure of implant.

The BIGSS lab has developed a Snake-like Dexterous Manipulator (SDM) for medical applications with a focus on orthopaedic surgery [1, 2]. One motivating application is the treatment of osteolysis (bone degradation) behind the well-fixed acetabular component of a total hip arthroplasty (THA). The SDM is composed of superelastic nitinol with a 4mm open lumen for inserting different tools (e.g., curette, drill, auger, pincer, brush, vacuum). The notches cut on the body constrain the SDM to bend in a single plane. The SDM is designed to fit through the screw holes of the acetabular implant of the THA (6mm OD) and actuated using independent solid stainless steel cables passing through its walls (Figure 3) [1].

In the envisioned application, the SDM will be positioned in the workspace by a robotic arm with at least six degrees of freedom (DoF) and uses screw holes in the acetabular implant as its entry to the patient's body (Figure 4). Controlling snake tip position requires concurrent control of the coupled SDM–robotic arm system. In this procedure, the screw hole acts as a RCM point, reducing the DoF of the robot. This RCM point can be created through hardware (e.g., the Laparoscopic Assistant Robot, LARS, [3]) or through virtual fixtures [4, 5].



Figure 3. APL SDM specifications.

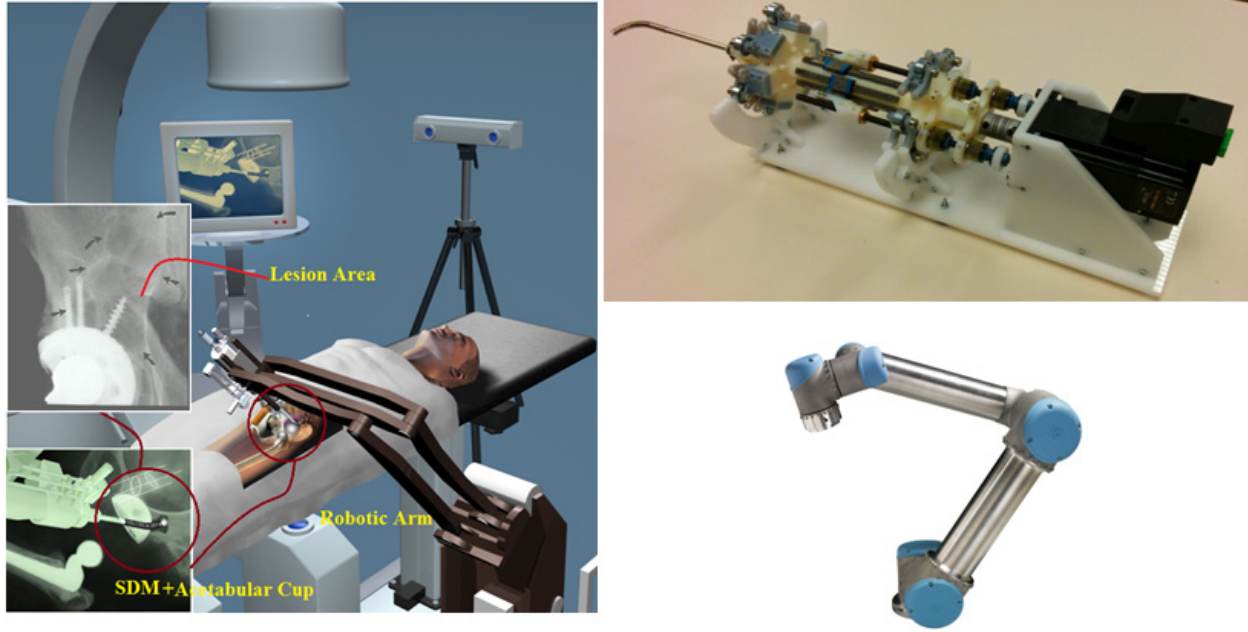

Figure 4. BIGSS lab a minimally-invasive surgical workstation (Left) – Universal robot and BIGSS SDM(Right)

For general applications using robotic arms without a mechanical RCM (e.g., UR5, Universal Robotics), recent literature suggests approaches developing a library of virtual fixtures for task primitives. These virtual fixtures were utilized for controlling the JHU Steady Hand robot [3], robotically- assisted sinus surgery [6], and suturing for minimally invasive surgery of the throat and upper airways [7]. These works were formulated as a constrained optimization problem where the goal was to obey the constraints and follow the desired motion as close as possible. Kapoor et al. [7] controlled a coupled dexterous manipulator with a robotic arm using a constrained optimization algorithm. This approach, however, utilized a robotic arm with a mechanical RCM and a complete kinematic model of their dexterous manipulator to control the system.

In the first part of this project we modify this approach through the introduction of virtual fixtures for robots without a mechanical RCM. Moreover, our SDM is not well-characterized by the piecewise-constant curvature assumption reviewed by Webster et al. [8], requiring an experimentally-derived kinematic model [9].

Second part of this project is related to design and fabrication of a interfacing part for attachment of SDM to UR5 robot.

Technical Summary of Approach:

This project has been consisted of two main parts which briefly has been discussed in this section. First parts addresses controlling problem and solution and second part focuses on mechanical design.

Part I: Position Control of the coupled robot

For position control we should consider these points:

1. According to Figure 5 SDM entry is through the screw holes of acetabular cup therefore 2 degrees of freedom of the UR5 will be lost considering this constraint

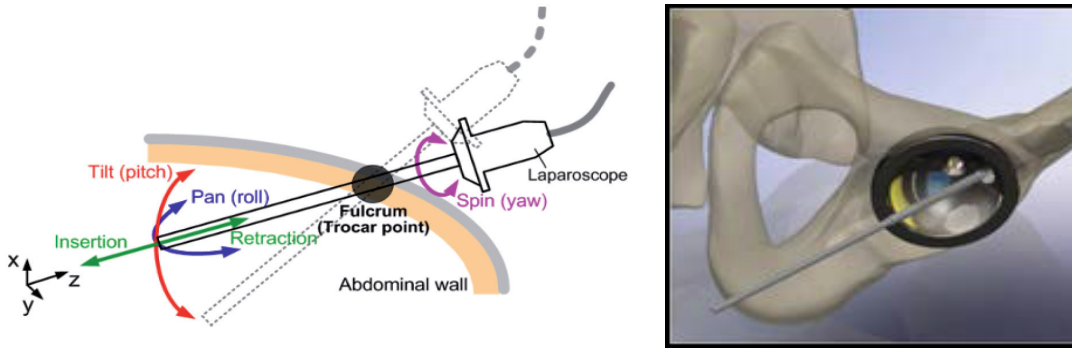

Figure 5. Limitation of the movement of SDM because of its entry.

2. The UR5 robot does not have a mechanical RCM point therefore we should create a virtual RCM point
3. There may not be enough space inside the pelvis and behind acetabular cup therefore some parts of SDM may remain outside the acetabular cup during part of the procedure. The virtual RCM in this situation would be on the flexible part which is a curve not a line. In this project we assume that all parts of the snake is inside the body.
4. Lateral forces of the cup may change the derived kinematic equations of the SDM. We assume that there is not any lateral force in this work.

Regarding these assumptions and considerations we have used virtual fixture algorithms to control the SDM [5-7]. We will use optimization to find the joint angles of the actuators regarding our constraints like virtual RCM and limitation on actuators velocities. Figure 6 briefly describes the control algorithm block diagram.

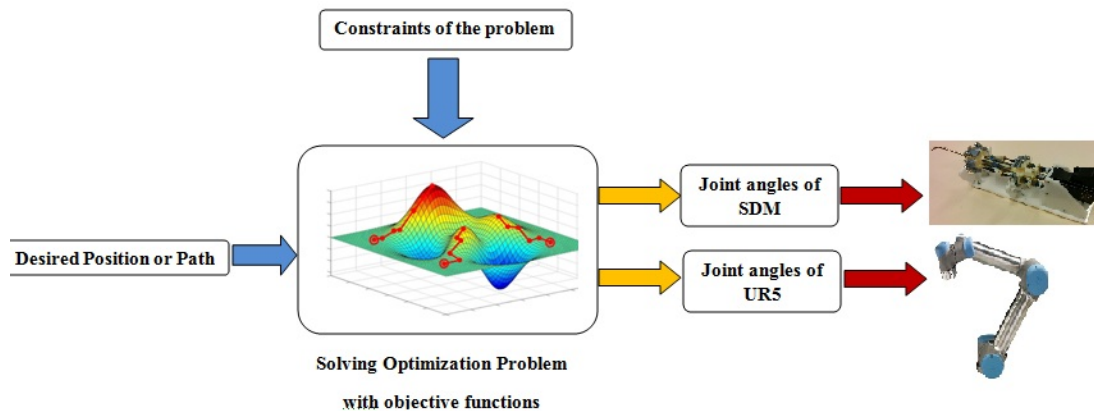

Figure 6. Control algorithm block diagram.

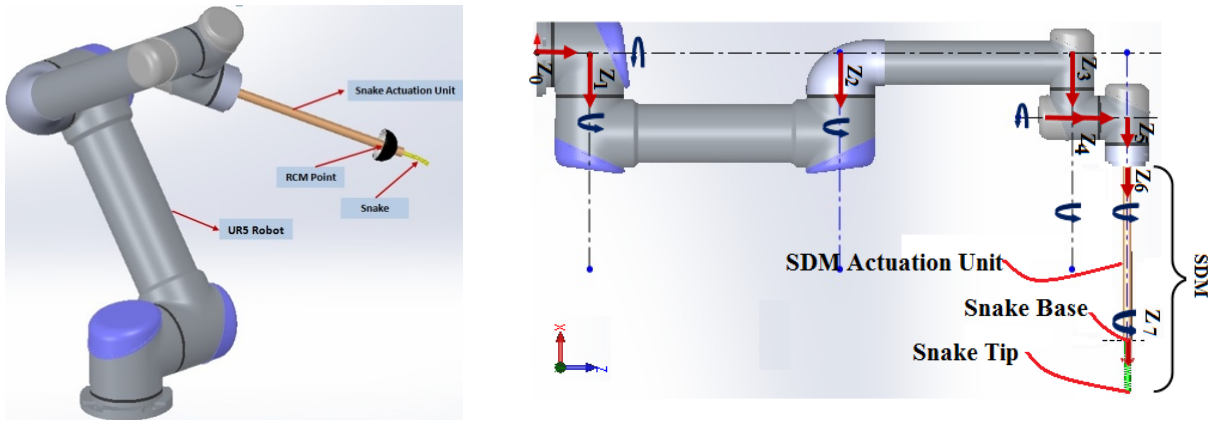

Figure 7. Defined D-H joint coordinate systems on the coupled robots

Considering the mentioned points in order to define our problem as an optimization problem we need to derive:

- ✓ Forward Kinematics of coupled robots
- ✓ Jacobian matrix of coupled robots
- ✓ Defining the constraints (RCM constraint+ Limitation on cable length and joint angles)

Kinematics Model of the robots:

➤ **UR5 Robot:**

Our system couples a UR5 [10] (Universal Robotics, Denmark) and the SDM (Figure 4). UR5 has a non-spherical wrist with six revolute joints and a spherical workspace. For defining D-H (Denavit-Hartenberg) parameters of the UR5, six joint coordinate systems have been defined (Figure 7). The Z_i shows the Z direction of each frame corresponding to the axis of rotation of each joint. These parameters have been given in Table1.

Table1: Denavit-Hartenberg parameters of the UR5

θ (rad)	d (m)	a (m)	α (rad)
q1	0.089	0	$\pi/2$
q2	0	-0.425	0
q3	0	-0.392	0
q4	0.109	0	$\pi/2$
q5	0.095	0	$-\pi/2$
q6	0.082	0	0

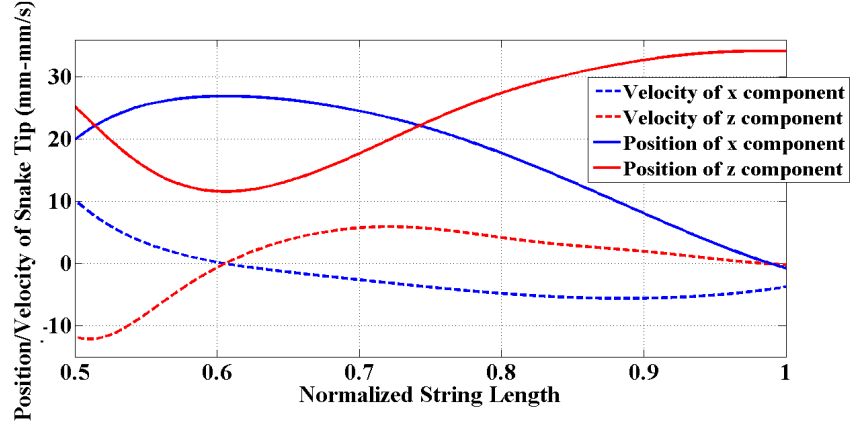

Figure 8. Components of tip velocity and position of SDM based on normalized string length. The characterized range of normalized string length is between 0.5 and 1 based experimental tests and SDM bending [9]

Using these D- H parameters forward kinematics can be calculated through (1):

$$T_{Snakebase}^w = T_1^w \cdot T_2^1 \cdot T_3^2 \cdot T_4^3 \cdot T_5^4 \cdot T_6^5 \cdot T_{Snakebase}^6 \quad (1)$$

T_i^j is a transformation from i^{th} coordinate to j^{th} coordinate. The velocity of the base of the SDM is related to the UR5 joint angles via the instantaneous direct kinematic Jacobian, $J_{UR5} \in \mathbb{R}^{6 \times 6}$, as:

$$\dot{x}_{Snakebase}^w = J_{UR5} \cdot \dot{q}_{UR5} = \begin{bmatrix} J_{vUR5} \\ J_{\omega UR5} \end{bmatrix} \cdot \dot{q}_{UR5} \quad (2)$$

➤ Snake-Like Dexterous Manipulator (SDM):

A series of experimental tests identified the relation between cable length (l) and tip position (p) [9]. In this method, nonlinear least-squares optimization has been used to fit a linear combination of Bernstein basis polynomials to the data for determining p_x . Afterward, p_z has been calculated based on p_x as sum of three sinusoids.

$$\begin{aligned} p_x &= f_1(\hat{l}) = B_n(\hat{l}) \\ p_y &= 0 \\ p_z &= f_2(p_x) = \sum_{i=1}^3 a_i \sin(b_i \cdot p_x + c_i) \end{aligned}$$

$$P_{Snaketip}^{Snakebase} = \begin{pmatrix} p_x \\ p_y \\ p_z \end{pmatrix} = \begin{pmatrix} f_1(\hat{l}) \\ 0 \\ f_2(f_1(\hat{l})) \end{pmatrix} \quad (3)$$

\hat{l} is the normalized string length and B_n is an n th order Bernstein polynomial. Coefficients a_i , b_i , and c_i represent the fit parameters for the i^{th} sinusoid. Differentiating (3) gives end-effector linear velocity, V , as:

$$V_{Snaketip}^{Snakebase} = \dot{p}_{Snaketip}^{Snakebase} = \begin{pmatrix} \dot{p}_x \\ \dot{p}_y \\ \dot{p}_z \end{pmatrix} = \begin{pmatrix} \dot{f}_1(\hat{l}) \\ 0 \\ \dot{f}_2(f_1(\hat{l})) \end{pmatrix} \quad (4)$$

Where \dot{p}_x , \dot{p}_y , and \dot{p}_z are linear velocities of SDM tip. Figure 8 shows the SDM tip position and velocity as a function of normalized string length.

➤ Kinematics model of the coupled manipulators:

The forward kinematics and Jacobian of the coupled manipulators can be calculated using these relations:

$$\begin{aligned} p_{Snaketip}^w &= T_{Snakebase}^w \cdot p_{Snaketip}^{Snakebase} \\ \omega_{Snaketip}^w &= \omega_{Snakebase}^w \\ V_{Snaketip}^w &= V_{Snakebase}^w + R_{Snakebase}^w \cdot V_{Snaketip}^{Snakebase} \\ &+ \omega_{Snakebase}^w \times R_{Snakebase}^w \cdot p_{Snaketip}^{Snakebase} \end{aligned} \quad (5)$$

Where $T_{Snakebase}^w$ is the transformation from snake base to world coordinate that is known using (1), and $R_{Snakebase}^w$ is the rotation matrix from snake base to world coordinate. $p_{Snaketip}^{Snakebase}$ is the value of (3). $V_{Snaketip}^w$ is the tip velocity of the SDM in world coordinate which is calculated using (4).

The coupled system has 7 independent variables, six for the UR5 (θ_{UR5}) and one for the SDM (q_{SDM}): $q = [\theta_{UR5} \ q_{SDM}]$. Using this definition the combined Jacobian matrix and linear and angular velocity of SDM (\dot{x}_{snake}^w) is:

$$\begin{aligned} J_{combined} &= [J_{UR5} \ J_{Snake}]; J_{UR5} \in \mathbb{R}^{6 \times 6}, J_{Snake} \in \mathbb{R}^{6 \times 1} \\ \dot{x}_{snake}^w &= J_{combined} \cdot \dot{q}; J_{combined} \in \mathbb{R}^{6 \times 7}, \dot{q} \in \mathbb{R}^{7 \times 1} \end{aligned} \quad (6)$$

Constrained optimization control :

During the procedure, the SDM will be positioned in the workspace by a UR5 robot and accesses the lesion through the screw holes of an acetabular implant (Figure. 4). Ensuring the snake enters through the screw hole is achieved through the use of a virtual RCM applied to the UR5. Intraoperative control requires satisfying the RCM constraint while ensuring the SDM tip achieves the desired configuration. Solving this constrained optimization problem finds the joint angles of the coupled robots while minimizing the difference between the desired and actual robot tip [3].

A. Control Algorithm:

For this preliminary work we assume that the SDM has passed through one of the holes of acetabular cup and the snake is completely inside the body. Also, we assume that there is no external force changing the snake configuration. With known initial joint angles of the UR5 and string length of SDM we can calculate the initial position of the tip. Therefore, we can divide control algorithms to these steps:

1. Calculate actual position of the coupled robots using (1) and (4).

2. Calculate desired incremental motion in Cartesian space Δ_{pos} :

$$\Delta_{pos} = \text{Actual Position} - \text{Desired Position}$$

3. Consider Δt as a small time increment and use linear relations to approximate the incremental motion in Cartesian space, Δx as:

$$\begin{aligned} \dot{x}_{snake}^W &= J_{combined} \cdot \dot{q} \rightarrow \frac{\Delta x_{snake}^W}{\Delta t} = J_{combined} \cdot \frac{\Delta q}{\Delta t} \\ \rightarrow \Delta x_{snake}^W &= J_{combined} \cdot \Delta q \end{aligned}$$

4. Solve this constrained optimization problem minimizing the Euclidian error between desired and actual incremental motions through minimum joint motions of UR5 and SDM:

$$\begin{aligned} \Delta q &= \arg \min_{\Delta q} (\|\Delta x - \Delta_{pos}\|_2^2 + \|w \cdot \Delta q\|_2^2); \Delta q \in \mathbb{R}^{7 \times 1} \\ s.t. \quad A \cdot \Delta x &\leq b \end{aligned} \quad (7)$$

Where Δq is desired incremental motions of the 7 DOF of the coupled robots, w is a diagonal matrix for weights. A and b matrices define the the virtual RCM constraint and SDM string length constraint, respectively.

5. Update the robot state:

$$q_{New} = q_{Old} + \Delta q$$

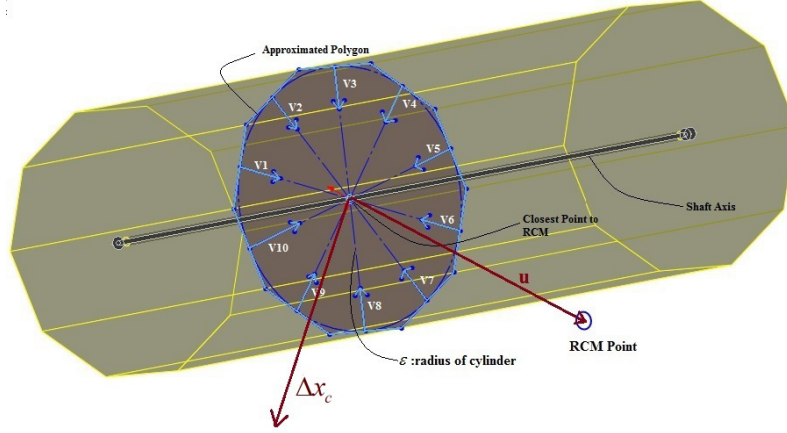

Figure 9. Components Defining RCM constraint based on approximated polygon

1) Virtual RCM constraint

The RCM limits movement perpendicular to the axis along the base of the SDM. This means that the distance between the closest point on the on the base axis to the RCM point in each time step should be less than a small value of ε . By this definition we confine movements in a virtual cylinder around the long axis of the base of the SDM with radius of ε (Figure 9).

$$\underbrace{\begin{bmatrix} v_1 \\ \vdots \\ v_m \end{bmatrix}}_{A_1} \cdot \Delta x_c \leq \underbrace{\begin{bmatrix} \varepsilon + v_1 \cdot u \\ \vdots \\ \varepsilon + v_m \cdot u \end{bmatrix}}_{b_1}; \quad (8)$$

$$\Delta x_c = J_{closest\ point} \cdot \Delta q_{UR5}; \Delta q_{UR5} \in \mathbb{R}^{6 \times 1}$$

Where Δx_c is the incremental Cartesian motion of the closest point on shaft and $J_{closest\ point}$ is the Jacobian matrix of this point. Vector u is the vector between RCM point and closest point on the shaft, vectors v_i are normal vectors of each side of the polygon which approximates the cylinder with radius ε .

2) Constraint on SDM string length

The kinematic model of the SDM has been derived such that we have these constraints:

$$0\ mm \leq q_{SDM} + \Delta q_{SDM} \leq 9\ mm$$

$$\underbrace{\begin{bmatrix} 1 \\ -1 \end{bmatrix}}_{A_2} \cdot \Delta q_{SDM} \leq \underbrace{\begin{bmatrix} 9\ mm - q_{SDM} \\ q_{SDM} \end{bmatrix}}_{b_2} \quad (9)$$

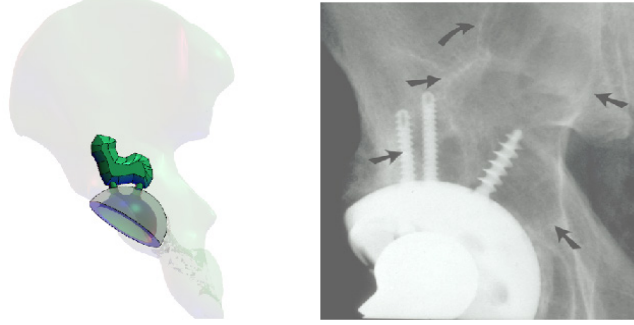

Figure 10. The simulated lesion area (left) and an example real x-ray image of a lesion (right). Note that the simulated lesion geometry does not correspond to the example geometry.

Where q_{SDM} is the string length and $\Delta q_{SDM} \in \mathbb{R}^{1 \times 1}$ is incremental change in cable length.

3) Combining constraints as matrix A and b :

The resulting constraints of (8) and (9) can be realized as a block diagonal matrix, A , and a vector, b :

$$\begin{bmatrix} A_1 & 0 \\ 0 & A_2 \end{bmatrix} \cdot \begin{bmatrix} J_{closest\ point} \\ 1 \end{bmatrix} \cdot \Delta q \leq \begin{bmatrix} b_1 \\ b_2 \end{bmatrix}; \Delta q \in \mathbb{R}^{7 \times 1} \quad (10)$$

Simulation and results:

We considered a 3D path for the snake that is a specific boundary of a simulated lesion and is inside a confined cubic space with sides of 7 cm (Fig. 10). The flexible portion of the SDM is 35mm and the actuation unit has a length of 30cm. The coupled system should be able to cover the simulated lesion while satisfying constraints described in the previous section. In this preliminary work we assumed that the flexible snake region is inside the body and no external force is applied to the tip of the SDM. For solving the constrained linear least-squares problem we have used lsqin function in Matlab.

Note that the constraints in this problem can be nonlinear; however, in this work we have used linear approximation because computation for a linear constrained quadratic optimization problem is efficient and robust [5]. Overall, the control architecture tracked the desired path well (Figure 11) with an average error of $4.2 \pm 2.1mm$. The maximum tip position error was 10mm, which occurred due to a sharp change in the path (Fig. 11).

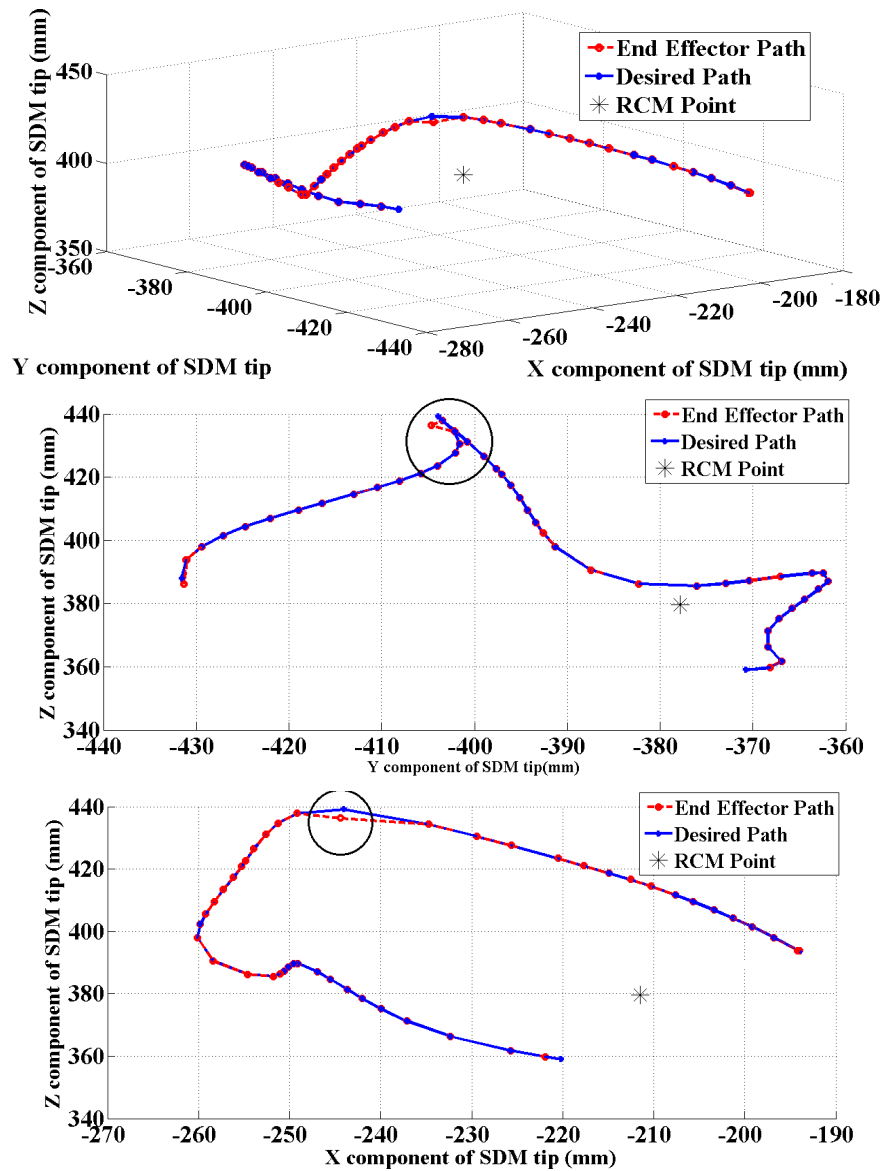

Figure 11. 3D view (up) , X-Z view (middle), and Y-Z view (down)of desired path and achieved positions by snake tip. The circle demonstrates the location of maximum deviation from the path.

In this simulation we have considered 4cm of snake base inside the body. Example snake configurations are presented in Figure 12. According to this figure we can see the robot has passed through RCM point and has not violated the constraints. Also, the robot changes its configuration such that with minimum joint movements the desired goal could be achieved while RCM constraint has been satisfied.

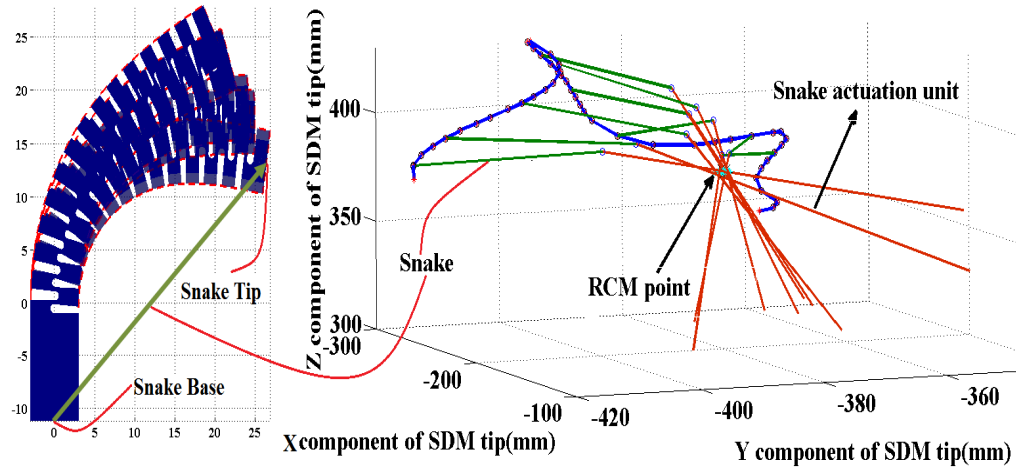

Figure 12. Optimization result for configuration (Left) and orientation of the snake and actuation unit (Right) in some points of the desired path.

Part II: Mechanical Design

The main purpose is to interface the SDM with UR5. This task involves:

1. Preparing CAD models of UR5, Actuation Unit, and Electronic Boards
2. Mechanical interface of the SDM to the UR5 considering:
 - UR5 has a 5kg load limit
 - Not changing existing actuation unit
 - Considering work space of the UR5
 - Considering a place for electronic boards of actuation unit
 - Considering enough space for wiring between boards and motors
3. Fabrication of mechanical parts
4. Ordering required mechanical parts (Screws, nuts, Expansion fits)
5. Assembly

So, in the first step CAD models of required parts (UR5 robot, SDM and its actuation unit, and electronic boards) were prepared. These parts have been shown in figure 13.

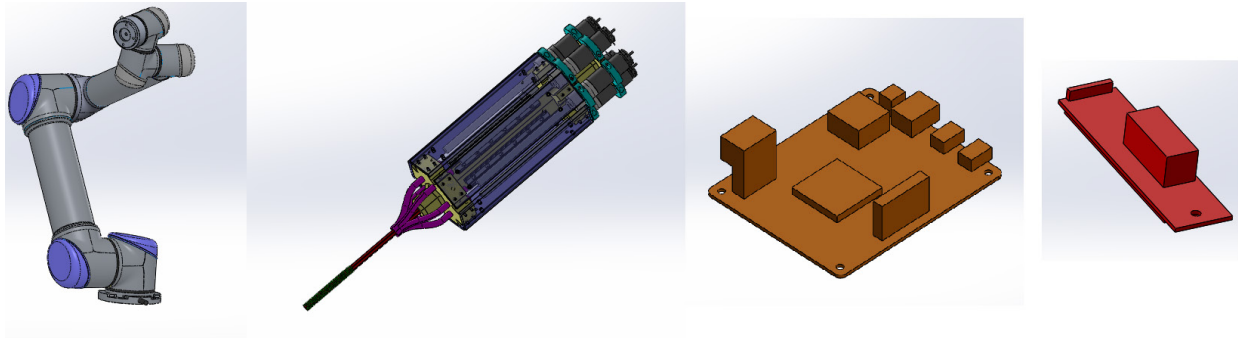
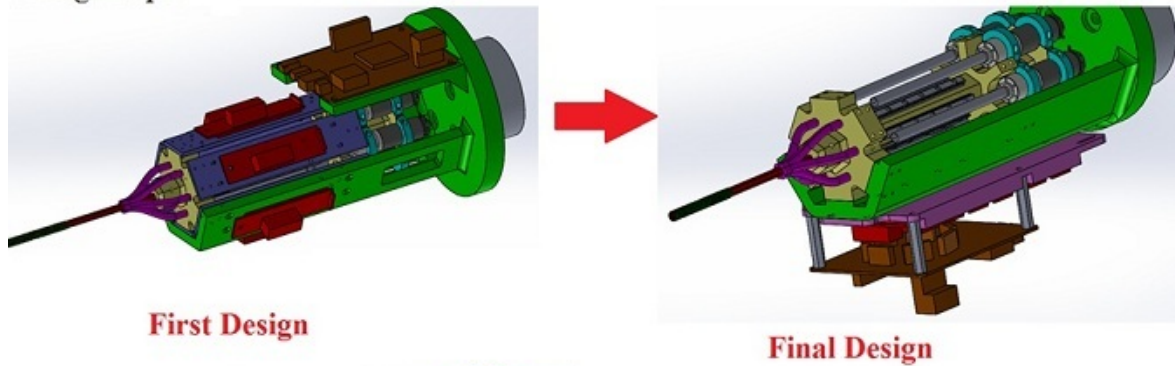

Figure 13. Preparing CAD models of required parts UR5 robot, SDM and its actuation unit, and electronic boards

Using these models, interface plates was designed. You can see the design steps in figure 14. As you can see two parts have been designed, one for interfacing the SDM to UR5 and one for placing electronic boards on it.

Design steps:



Designed Parts:

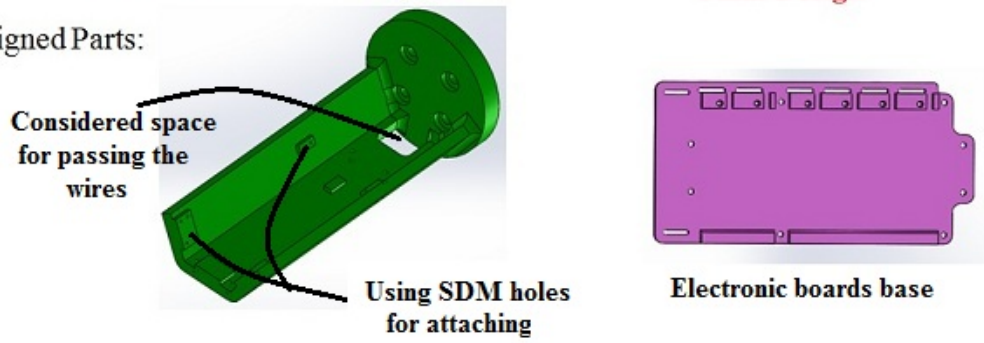

Figure 14. Design steps and designed parts

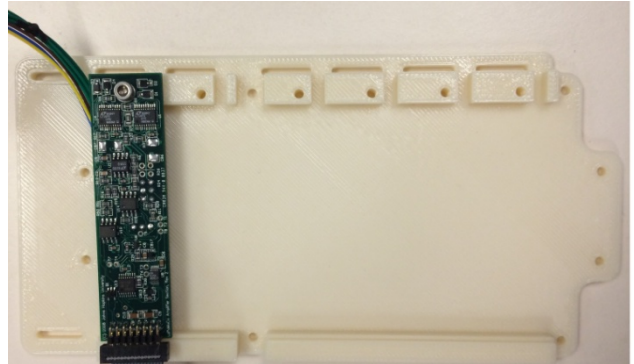
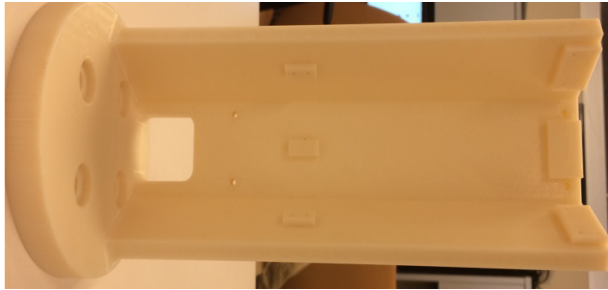

Figure 15. Fabricated parts using 3D printer

After design process because of limitation on payload of UR5, we decided to use 3D printer for fabricating designed parts. These parts have been shown in figure 15. Required parts for assembly were ordered and the complete assembled robots have been shown in figure 16.

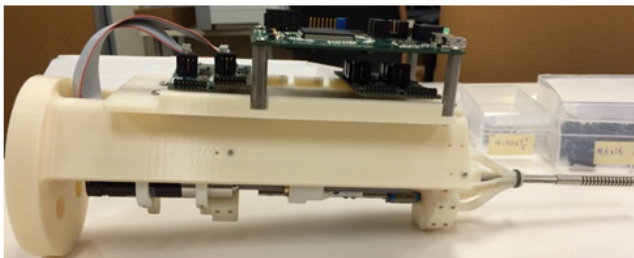
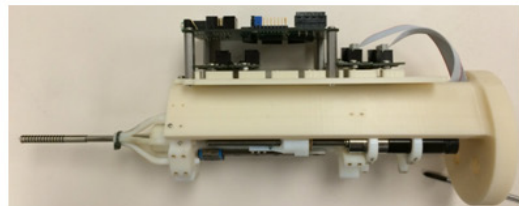
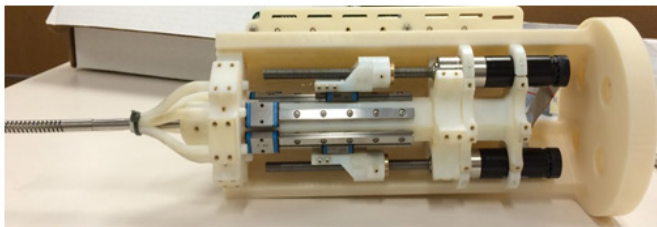

Figure 16. Assembled robots

Management Plan- Detailed Task Schedule and deliverables:

Figure 17 shows the first detailed task schedule and figure 18 demonstrates final task schedule. As we can see we have a new added deliverable which is a submitted paper in IEEE conference. Also, Maximum deliverables abandoned for this semester. According to the final time schedule, except than implementing control algorithm on the hardware all minimum and expected deliverables have been achieved. We cannot work experimentally because UR5 control box faced some errors. We decide to complete all of the deliverables in summer.

Task	9-Feb	16-Feb	23-Feb	2-Mar	9-Mar	16-Mar	23-Mar	30-Mar	6-Apr	13-Apr	20-Apr	27-Apr	4-May	9-May
Preparing a 3-D model of the UR5	😊											🟢	🟡	
Deriving the Kinematics model of UR5	😊											🟢	🟡	
Simulation of the model in Simmechanics-Matlab	😊	🟡										🟢	🟡	
Obtaining CAD models of Snake												🟢	🟡	
Obtaining Kinematic model of Snake and working with it												🟢	🟡	
Literature survey for virtual fixture		😊										🟢	🟡	
Mechanical interface of snake to UR5					🟡							🟢	🟡	
Ordering required parts and actuators												🟢	🟡	
Fabrication of first coupled robot								🟡				🟢	🟡	
Simulation of the inverse kinematics of the coupled robots								🟡				🟢	🟡	
Working with and setting up the UR5 robot								🟡				🟢	🟡	
Controlling the coupled robots (Minimum Deliverable)									🟡			🟢	🟡	
Simulation of virtual fixture (RCM point is not on the snake)											🟡	🟢	🟡	
Testing the algorithm on Robots (Expected Deliverable)											🟡	🟢	🟡	
Simulation of virtual fixture (RCM point is on the snake)												🟡	🟢	
Testing the algorithm on Robots (Maximum Deliverable)												🟡	🟢	
Final report Presentation												🟡	🟢	🟡

Figure 17. First detailed task schedule

Task	9-Feb	16-Feb	23-Feb	2-Mar	9-Mar	16-Mar	23-Mar	30-Mar	6-Apr	13-Apr	20-Apr	27-Apr	4-May	9-May
Preparing a 3-D model of the UR5	😊											🟢	🟡	
Deriving the Kinematics model of UR5	😊											🟢	🟡	
Simulation of the model in Simmechanics-Matlab	😊	🟡										🟢	🟡	
Obtaining CAD models of Snake		🟡	🟡				😊					🟢	🟡	
Obtaining Kinematic model of Snake and working with it		🟡	😊	😊								🟢	🟡	
Literature survey for virtual fixture		😊	😊	😊								🟢	🟡	
Mechanical interface of snake to UR5			🟡	🟡	🟡	🟡	😊	😊	😊	😊		🟢	🟡	
Ordering required parts and actuators					🟡	🟡	🟡	🟡	🟡	😊	😊	🟢	🟡	
Fabrication of first coupled robot					🟡	🟡	🟡	🟡	🟡	😊	😊	🟢	🟡	
Simulation of the inverse kinematics of the coupled robots				😊	😊	😊	😊	😊				🟢	🟡	
Working with and setting up the UR5 robot				🟡	🟡	🟡	🟡	🟡	🟡	😊	😊	🟢	🟡	
Controlling the coupled robots (Minimum Deliverable)					🟡	🟡	🟡	🟡	🟡	😊	😊	🟢	🟡	
Simulation of virtual fixture (RCM point is not on the snake)						😊	😊	😊	😊			🟢	🟡	
Submitting paper in IEEE EMBS Conference (Added Deliverable)								😊	😊			🟢	🟡	
Testing the algorithm on Robots (Expected Deliverable)											🟡	🟢	🟡	😊
Simulation of virtual fixture (RCM point is on the snake)												🟡	🟢	
Testing the algorithm on Robots (Maximum Deliverable)												🟡	🟢	
Final report Presentation												🟡	🟢	😊

Figure 18. Final detailed task schedule

Final Deliverable Status:

Figure 19 shows final deliverable status of the project.

Final Deliverables status

Minimum

- Deriving and implementing the kinematic equations of UR5: 😊
- Interfacing the SDM with UR5 (Mechanical design and fabrication): 😊
- Coupled inverse control of robots outside the body: 😊

Expected

- Controlling the position of the coupled robots using virtual RCM when all of the SDM is in the body ([Simulation](#) and [Implementation](#)): 😊 + 😊

Added Deliverable

- Submitting paper in IEEE Conference of Engineering in Medicine and Biology Society (EMBS'14) 😊

Maximum

- Controlling the position of the coupled robots using virtual RCM when all of the SDM is not in the body (Simulation and implementation)
- Modeling the kinematics of SDM using solid mechanics or beam theory

Figure 19. Final deliverable status

Conclusion and future works:

In first part of this work we used the constrained optimization algorithm and virtual fixture method to control the position of a coupled continuum robot and 6 DoF robotic arm inside a confined space. For modeling the kinematics of the SDM we have used the results of experiments in [9] to derive the relation between cable change and tip velocity.

In the second parts, interface parts were designed, fabricated, and assembled using 3D printer.

Future work includes:

1. Implementing the control approach on hardware:
For this work first we should setup the UR5 robot. Unfortunately control box of this robot faced with some problems and we could not implement our algorithm on it.
2. Solving this problem for a snake with the flexible region outside the patient's body:
As, mentioned before in real surgery situation, the space is so confined and may some parts of the snake remains outside of the body. Therefore, this problem is much defaulter than the solved problem in this project.

3. Redesigning mechanical interface which allows us to insert different tools inside the snake: During surgery different tools insert in the snake lumen. So, we should redesign the mechanical part considering this fact.
4. Working on kinematics and dynamics model of SDM using Solid Mechanics approach: We assumed that there are no external forces on the snake however in real situation different loads exerted to robot. So, we need a reliable model to deal with these forces.

Reading List & Bibliography:

- [1] M. D. M. Kutzer, S. M. Segreti, C. Y. Brown, M. Armand, R. H. Taylor, and S. C. Mears, "Design of a new cable-driven manipulator with a large open lumen: Preliminary applications in the minimally invasive removal of osteolysis," in *Proc. IEEE Int Robotics and Automation (ICRA) Conf*, 2011, pp. 2913–2920.
- [2] R. J. Murphy, M. D. M. Kutzer, S. M. Segreti, B. C. Lucas, and M. Armand, "Design and kinematic characterization of a surgical manipulator with a focus on treating osteolysis," *Robotica*, 2014, in press.
- [3] A. Kapoor, M. Li and R. H. Taylor, "Constrained Control for Surgical Assistant Robots", in *Proc. of the 2006 IEEE International Conference on Robotics and Automation*, Orlando, Florida , 2006.
- [4] L. B. Rosenberg, "Virtual fixtures: Perceptual tools for telerobotic manipulation," in *IEEE Virtual Reality Annual International Symposium*, Seattle, USA, 1993, pp. 76–82.
- [5] J. Funda, R. H. Taylor, B. Eldridge, S. Gomory, and K. G. Gruben, "Constrained cartesian motion control for teleoperated surgical robots," *IEEE Trans. Robot.* vol. 12, no. 3, pp. 453–465, 1996.
- [6] M. Li, M. Ishii, and R. H. Taylor, "Spatial Motion Constraints Using VirtualFixtures Generated by Anatomy," *IEEE Trans. Robotics*, vol. 23, no. 1, 2007.
- [7] A. Kapoor, N. Simaan, and R. H. Taylor, "Suturing in Confined Spaces: Constrained Motion Control of a Hybrid 8-DoF Robot," in *Proc. of the 12th International Conference on Advanced Robotics*, 2005.
- [8] R. J. Webster and B. A. Jones, "Design and kinematic modeling of constant curvature continuum robots: A review," *The International Journal of Robotics Research*, vol. 29, no. 13, pp. 1661–1683, Nov 2010.
- [9] R. J. Murphy, Y. Otake, R. H. Taylor, and M. Armand, "Predicting Kinematic Configuration from String Length for a Snake-like Manipulator Not Exhibiting Constant Curvature Bending," in *Intelligent Robots and Systems (IROS)*, 2014, submitted for publication.
- [10] <http://www.universal-robots.com>