

Kinematic design considerations for minimally invasive surgical robots: an overview

Chin-Hsing Kuo, Jian S. Dai, and Prokar Dasgupta

Zaid Ashai

Group 3

Mentors: Kevin Olds, Allen Feng, and Dr. Taylor

Project Statement

Integrating novel surgical instruments into the
REMS for robot assisted vein anastomosis

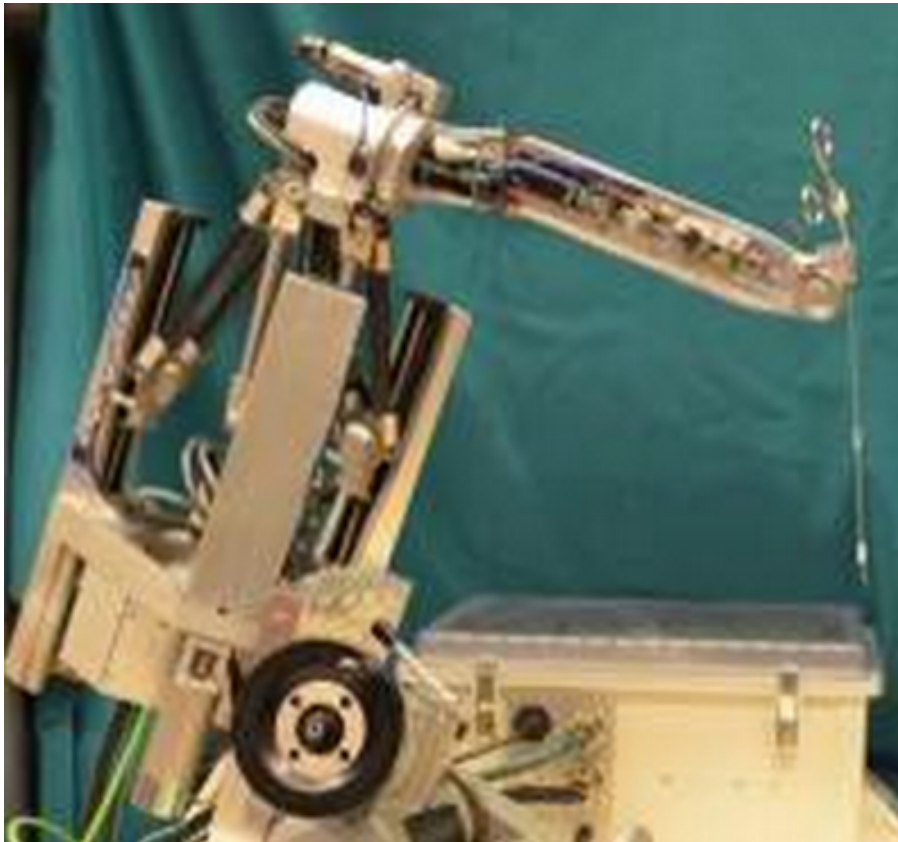

Background

- A minimally invasive surgical (MIS) robot may be an active, passive or co-manipulated robot working near the patient, and is either hand- or computer-controlled to maneuver the surgical instrument(s) executing the intraoperative MIS task inside the patient's body.
- Remote center-of-motion (RCM) is a fixed point, either mechanically or virtually, associated with a mechanism about which some link(s) in the mechanism rotate

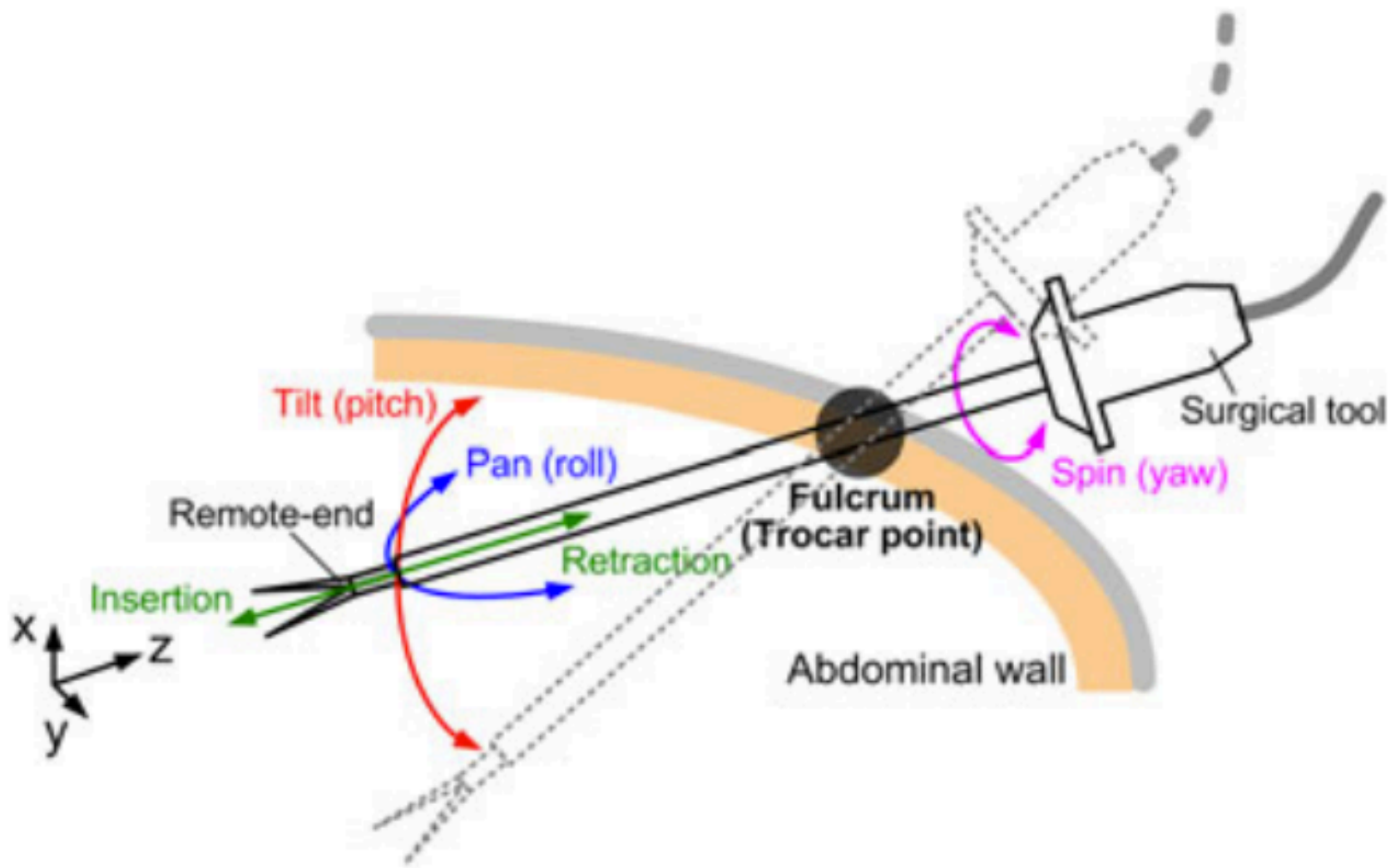

Figure 1. The four degrees of freedom of motion for an MIS instrument

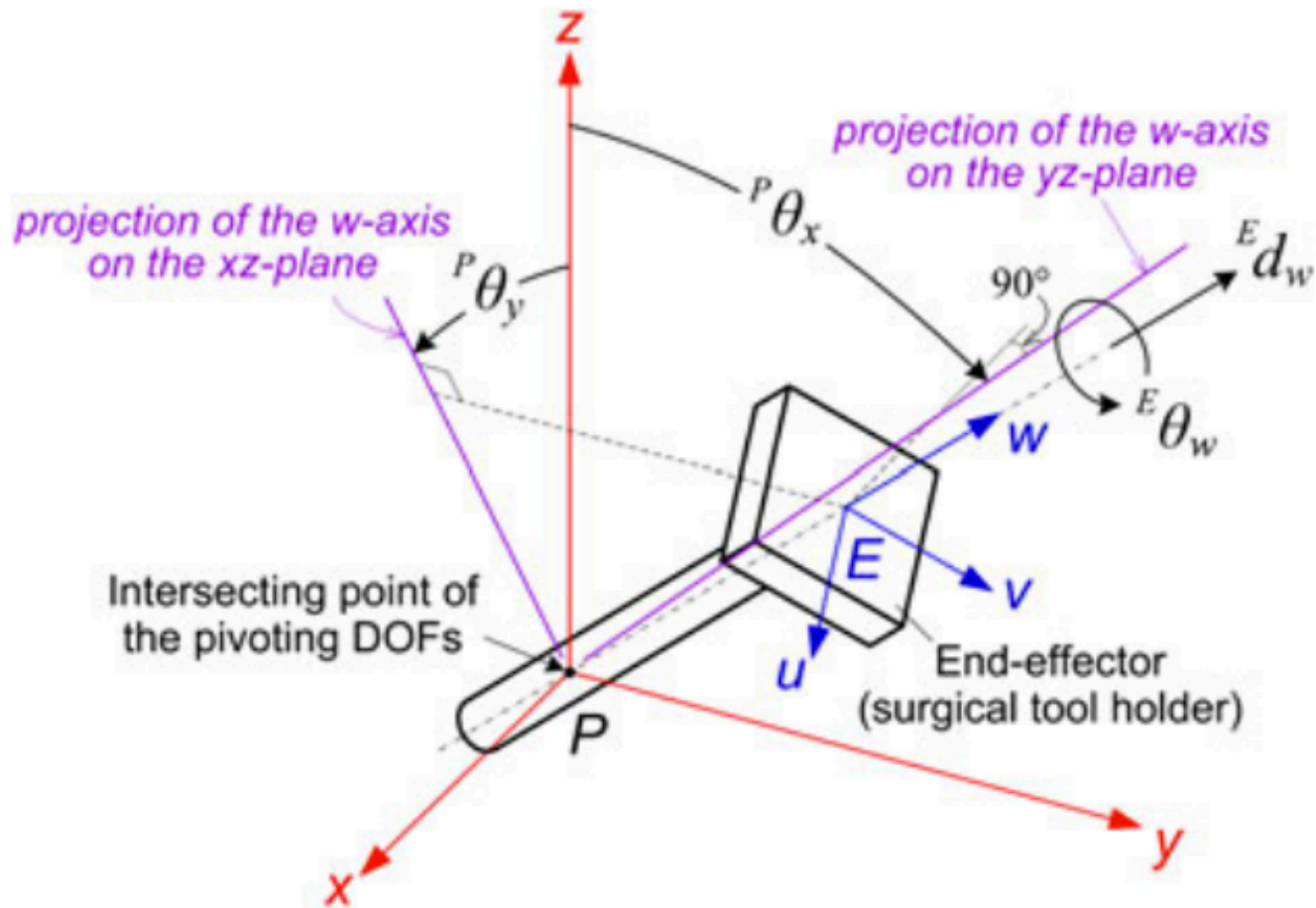

Figure 2. Four practical DOFs used in an MIS instrument

$$\begin{bmatrix} P \dot{\theta}_x \\ P \dot{\theta}_y \\ E \dot{\theta}_w \\ E \dot{d}_w \end{bmatrix} = \mathbf{J} \begin{bmatrix} \dot{q}_1 \\ \dot{q}_2 \\ \dot{q}_3 \\ \dot{q}_4 \end{bmatrix}$$

Purpose

- Identify kinematic constraints of MIS robots
- Discuss design problems of robot assisted MIS
- Formulate a list of kinematic design goals for MIS robots
- Define the remote center-of-motion (RCM) mechanism
- Classify MIS robots based on their RCM implementation
- Evaluate RCM implementations based on the defined list of kinematic goals

Methods

Safety:

- DG1- kinematic constraint at the entry point
- DG2- collision-free workspace
- DG3- decoupled rotational and translational DOF

Accuracy:

- DG4- low output displacement/input displacement ratio

Methods

Ergonomics:

- DG5- inverted hand-eye coordination
- DG6- rotational ability of the end-effector

Dexterity:

- DG7- hand tremor reduction
- DG8- surgical movement scaling

Methods

- Decoupling = Independent movement in each DOF
- Low output/input ratio = maximum displacement at tool tip using the minimum displacement of robot joints
- Isotropy = how well the motion and force generated by the actuations can be delivered to the instrument
- Backdrivability = Enables or disables manual movement of robotic joints in emergencies (safer if disabled)
- Redundancy = More actuators/joints than needed for robotic movement

RCM type

Kinematic structure sketch

Sampled MIS Robot

Isocenter

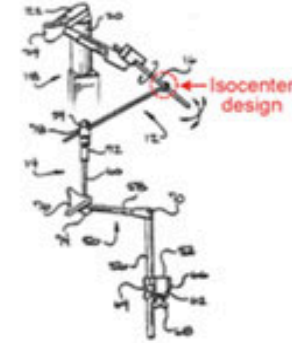
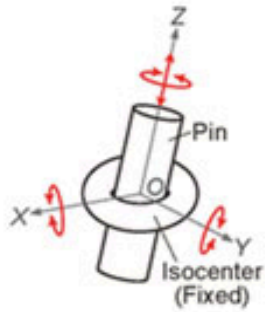

Circular tracking arc

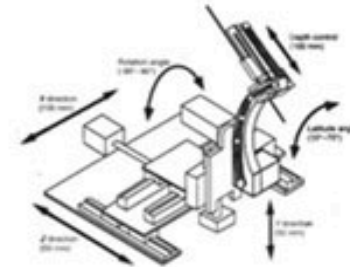
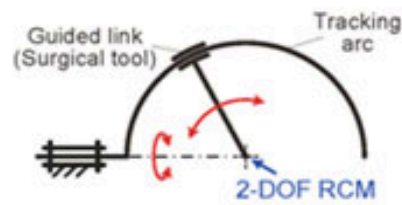

Parallelogram

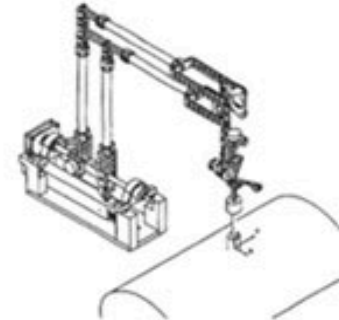
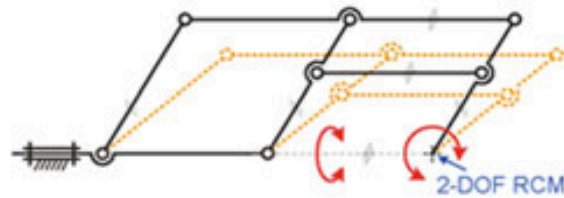

Belt

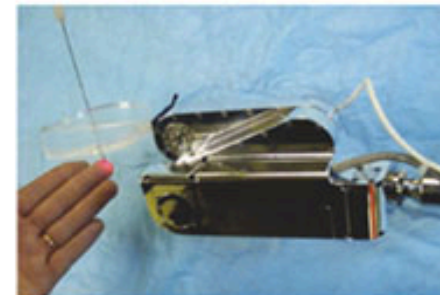
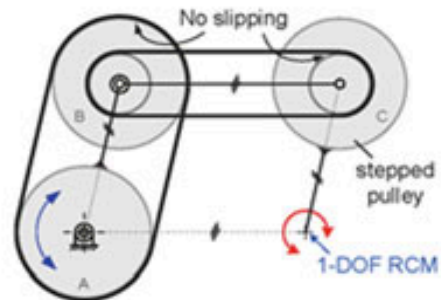

Spherical linkage

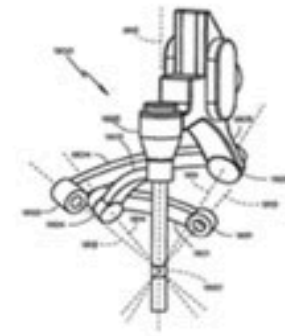
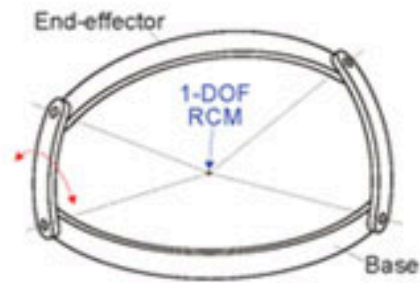

Gimbal

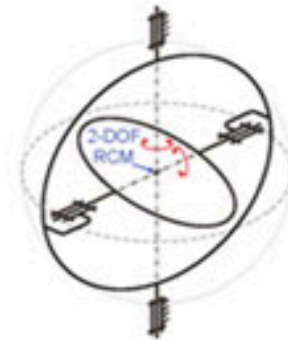

Parallel wrist mechanism

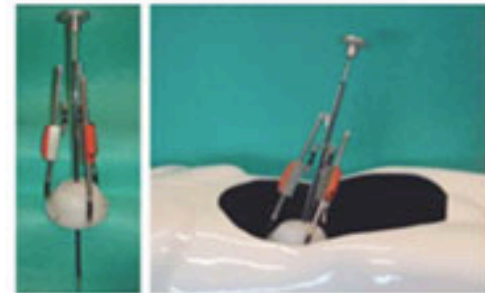
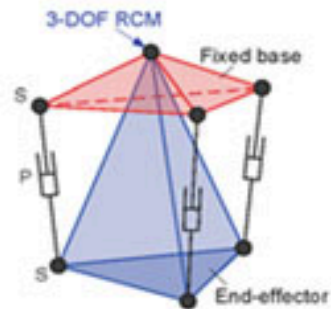

Gear train

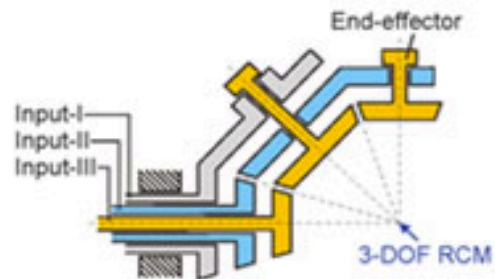

Results

- Classification of MIS robots based on RCM type and number of associated DOF
- Comparison of the eight RCM mechanism types by their kinematic qualities:
 - decouplability
 - extracorporeal workspace
 - task-oriented isotropy
 - backdrivability

Table 3. Sample minimally invasive surgical robots using RCMs

Robot	Institution	Country	Year	RCM DOF*	RCM Type
AcuBot	Johns Hopkins Univ./ Georgetown Univ.	USA	2001	2R	synchronous belt
Active Trocar	Univ. of Tokyo	Japan	2002	2R	parallelogram
AESOP	Computer Motion	USA	1992	2R	passive RCM
ARTEMIS	Eberhard Karls Univ./ Karlsruhe Res. Center	Germany	1996	2R	parallelogram
Black Falcon	Massachusetts Institute of Technology	USA	1998	2R	parallelogram
BlueDRAGON	Univ. of Washington	USA	2002	2R	parallelogram
CoBRASurge	Univ. of Nebraska-Lincoln	USA	2008	3R	gear train
CLEM	Institut Albert Bonniot	France	2002	3R1T	isocenter (flexible straps)
da Vinci	Intuitive Surgical	USA	1999	2R	parallelogram
EndoBot	Rensselaer Polytechnic Institute	USA	2001	2R	circular tracking arc
EVOLAP	UcLouvain/LIRMM	Belgium	2009	2R	parallelogram with passive RCM
FIPS Endoarm	Eberhard Karls Univ./ Karlsruhe Res. Center	Germany	1999	2R	circular tracking arc
KineMedic	German Aerospace Center (DLR)	Germany	2006	-	non-mechanical
LARS	IBM	USA	1995	2R	parallelogram
MARGE	French National Research Center	France	2001	-	non-mechanical
MARS	Technion—Israel Institute of Technology	Israel	2003	-	non-mechanical
MC ² E	Univ. of Paris	France	2004	2R	spherical linkage
MHU	Miguel Hernandez Univ. <i>et al.</i>	Spain	2010	3R	parallel wrist manipulator
MicroHand	Tianjin University	China	2005	2R	crclular tracking arc
MicroHand A	Tianjin University	China	2010	2R	synchronous belt
Naviot	Hitachi	Japan	2003	2R	isocenter
Neurobot	Imperial College London	UK	2000	2R	parallelogram
PADyC	Universite' Joseph Fourier	France	2001	-	non-mechanical
PAKY-RCM	Johns Hopkins Univ.	USA	1998	2R	synchronous belt
PantoScope	Swiss Federal Institute of Technology	Switzer- land	1997	2R	parallelogram
Probot	Imperial College London	UK	1991	2R	circular tracking arc
RAVEN	Univ. of Washington	USA	2006	2R	spherical linkage
Siemens CT	Siemens AG	Germany	2000	2R	parallelogram
SpineNav	Nankai Univ./Dalian Neusoft Institute of Information	China	2008	-	non-mechanical
Steady-Hand	Johns Hopkins Univ.	USA	1999	2R	synchronous belt
UBC-US	Univ. of British Columbia	Canada	1999	2R	parallelogram
UCB/UCSF	UC Berkeley/UC San Fran.	USA	1999	-	non-mechanical
UMI	Univ. of Tokyo	Japan	2002	1R	circular tracking arc
UT-LAP	Univ. of Tokyo	Japan	1999	2R	isocenter
UT-MRI	Univ. of Tokyo	Japan	2002	1R	non-mechanical
UT-NEU	Univ. of Tokyo	Japan	1998	2R	circular tracking arc
VESALIUS	K.U.Leuven	Belgium	2003	2R	parallelogram
ViKY	EndoControl	France	2003	2R	circular tracking arc
Zeus	Computer Motion	USA	1998	3R	passive RCM

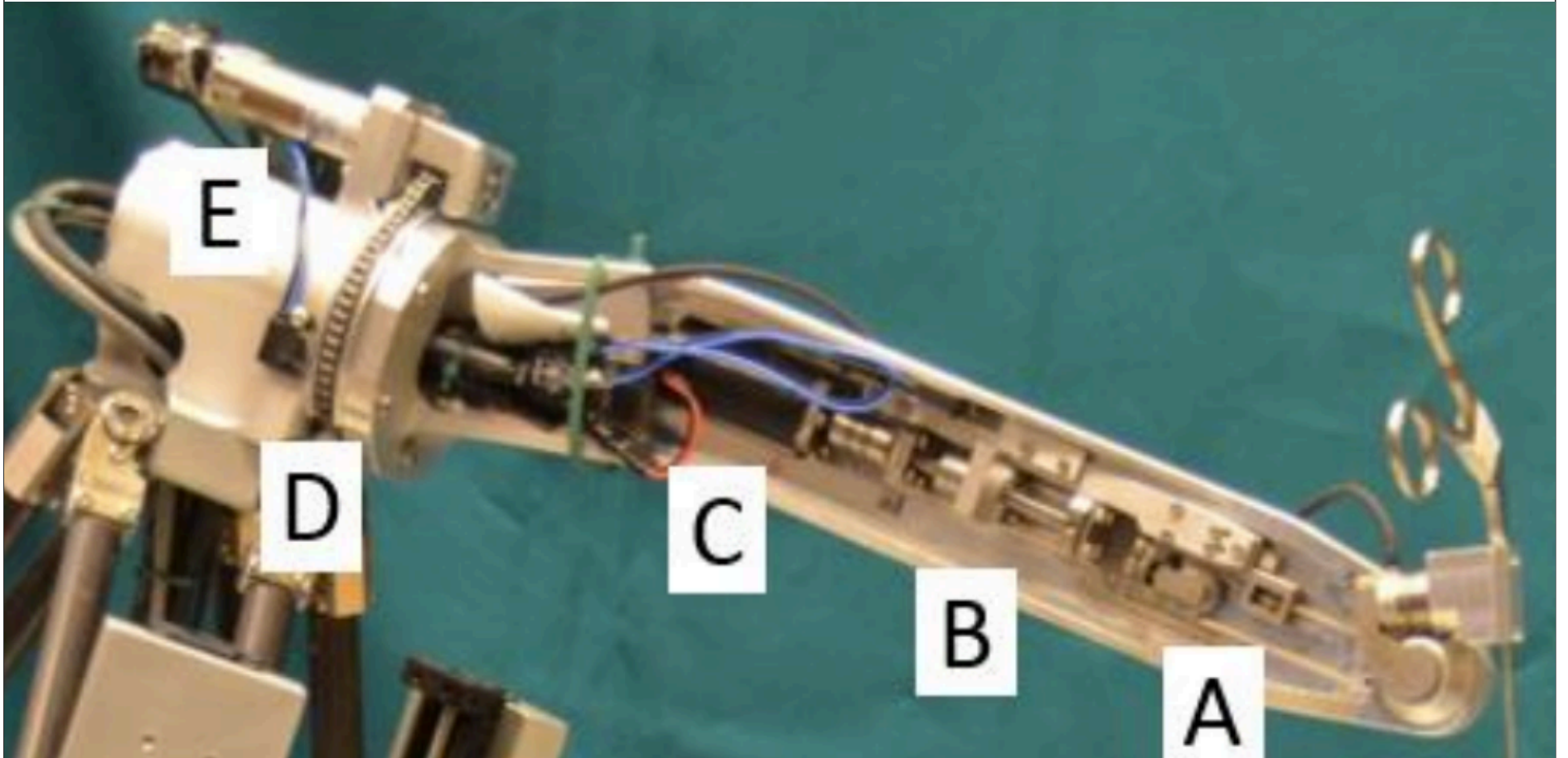

Table 4. Comparison of the MIS robots based on RCM mechanism type

"Mechanism design issues" vs. "RCM mechanism types"			RCM mechanism type								
			<i>Isocenter</i>	<i>Circular tracking arc</i>	<i>Parallelogram</i>	<i>Synchronous belt</i>	<i>Spherical linkage (open chain)</i>	<i>Spherical linkage (closed chain)</i>	<i>Gimbal</i>	<i>Parallel wrist mechanism</i>	<i>Gear train</i>
Mechanism design issues	RCM DOFs	2-DOF rotation (2R)	A	A	A	A	A	A	A	A	A
		3-DOF rotation (3R)	A	A	B	B	A	A	A	A	A
		2-DOF rot. + 1-DOF trans (2R1T)	A	B	B	B	B	B	B	B	B
		3-DOF rot. + 1-DOF trans (3R1T)	A	B	B	B	B	B	B	B	B
	Task-oriented 4-DOF decouplability	Type-I (<i>T</i> decoupled)	-	B	B	B	B	B	B	B	B
		Type-II (Some <i>R</i> 's decoupled)	-	A	A	A	A	-	A	A	A
		Type-III (Some <i>R</i> 's & <i>T</i> decoupled)	-	B	B	B	B	-	B	B	B
		Type-IV (All <i>R</i> 's decoupled)	-	-	-	-	-	-	-	A	-
		Type-V (All <i>R</i> 's & <i>T</i> decoupled)	-	-	-	-	-	-	-	B	-
	Extracorporeal workspace	-	A	A	A	A	A	A	-	A	A
Task-oriented fully-isotropic 3R1T	-	-	-	-	-	-	-	-	B	-	
Backdrifiability	-	A	A	A	A	A	A	A	A	A	

^AAchievable/available.

^BAchievable/available but auxiliary instrumentation required.

^TNot achievable/applicable.

Significance

- Lays out much needed kinematic guidelines for designing MIS robots
- Thoroughly explains mechanisms for achieving the design goals it defines
- Provides a rudimentary comparison of MIS robots based on the efficiency of their RCM mechanisms
- Represents tool motion mathematically

Limitations

- Lack of quantitative data to support claims
- Based solely off information in other journals and the authors' experiences
- No ranking of RCM mechanisms and MIS robots
- Focuses on laparoscopic procedures

Redemption

- ~100 referenced articles > possible shortcomings in authors' experiences
- Lists design goals and kinematic mechanisms pertinent to MIS robots
- Thoroughly analyzes RCM techniques and classifies existing RCM MIS robots
- Defines mechanical terms in great detail

Conclusion

Done well:

- Identify kinematic constraints of MIS robots
- Discuss design problems of robot assisted MIS
- Formulate a list of kinematic design goals for MIS robots
- Define the remote center-of-motion (RCM) mechanism
- Classify MIS robots based on their RCM implementation

Needs improvement:

- Evaluate RCM implementations based on the defined list of kinematic goals