

# Data Acquisition Board for Stroke Rehabilitation Hand Device

Jacob Carducci, Kevin Olds  
KATA Lab, Department of Neurology, JHMI  
Baltimore, Maryland, USA

**Abstract**—In an effort to enhance the current version of a force-sensing rehabilitative tool, known tentatively as the Stroke Rehabilitation Hand Device, a new data acquisition board with 20 analog channel support was designed and evaluated. By creating a PCB unit of the DAQ design for use in the Hand Device, adjusting and calibrating a patient’s finger-generated forces for proper data processing is easier and more viable. This results in quicker treatment and recovery for the patient.

**Keywords**—data acquisition, rehabilitation, signal processing, PCB design, amplification, I<sup>2</sup>C, stroke, hand device

## I. BACKGROUND

Motor-neurological injuries, especially stroke, have negatively impacted the quality of life for numerous individuals nationwide. Arguably one of the more debilitating injuries are lesions that affects the strength and control of the hands and upper limbs, which makes it difficult to perform everyday tasks including grabbing objects and interacting with computers.

Researchers at Johns Hopkins’ own Department of Neurology have recently completed a study into post-stroke recovery of the human hand, where they have explored how the strength and control of fingers improves over time for various degrees of stroke [1]. They tracked the maximum voluntary contraction force of each finger to measure strength, while they compared the force generated by the active finger compared to the passive fingers to quantify individuation / control. They found that both strength and control in these forms improve the most within the first three months (or twelve weeks) of recovery. Therefore, it is key to introduce rehabilitation to the patient as early as possible to improve the chances and effectiveness of recovery, which can lead to a better quality of life for the patient.

There are pre-existing solutions on the market that attempt to provide upper-limb rehabilitation, but they possess serious characteristic flaws that limit their effectiveness. The Amadeo system manufactured by Tyromotion relies on linear motion sensing and actuation to provide rehabilitation [2]. An apparent limitation of this solution would be that the system is not very portable and is restricted to a clinical or medical environment. Additionally, there is considerable time needed for the patient to secure their wrist and fingers to the device, and weaker patients may not be able to overcome the internal friction needed to move the finger beams. Another commercial example is the Rapael from NEOFECT, which is a flexible, glove-like device that integrates bend sensors to detect the

patient’s hand motion. However, the bend sensors can detect only one direction and can still be too stiff for weaker patients to flex [2]. In the academic field, researchers at Gifu University in Japan have developed a robotic exoskeleton with multi-axis key sensors that can accommodate small motions from weak users. However, the exoskeleton is expensive from its inherent complexity and its numerous force sensors for each finger. The exoskeleton is also heavy and can pinch the user, making home use highly impractical [2,4].

The group I am collaborating with believes that a low-cost, portable, and easy-to-use device can be developed for effective rehabilitation both in a clinical and in a home environment. Their answer is the Stroke Rehabilitation Hand device, which is realized currently as a preliminary prototype, shown in Fig. 1. The existing prototype utilizes a NI USB-6001 DAQ board, shown in Fig. 2. This component of the device provides an electronic bridge between the finger sensors and the computer, and can amplify and process force signals. The most significant limitation of the current implementation is that it can support up to eight analog channels. Since each finger sensor requires four independent channels, the NI board can read from a maximum of two fingers. The goal of the new prototype’s data acquisition subsystem is to increase the channel count from 8 to 20 channels to support all five digits of the typical human hand. To that end, a novel custom data acquisition board was developed.

## II. BOARD DESIGN APPROACH



Figure 1: User hand fitted into first prototype of Stroke Rehabilitation Hand Device

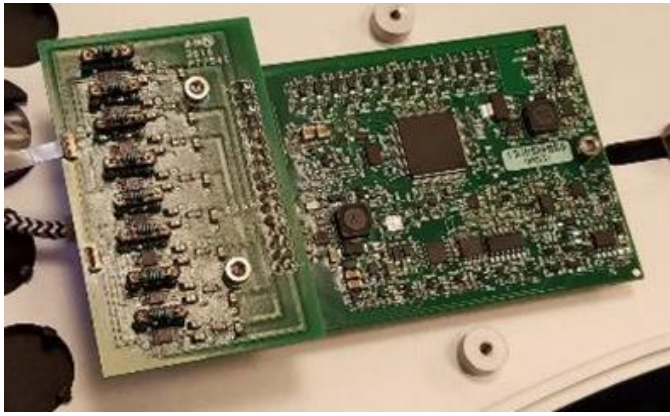

Figure 2: NI USB-6001 DAQ board with breakout channel board for finger sensors

The custom data acquisition unit will be a four-layer printed circuit board with three categories of surface-mount elements: microprocessor, amplifiers, and multiplexers. The schematic of the DAQ unit is shown in Appendix A.

The microprocessor is a Teensy 3.5 USB Development board from PJRC, as shown in Fig. 3 [3]. The purpose of this board is to process and organize amplified signals from the finger sensors into readable serial information for the computer. It can also process commands from the computer to modify the amplifying transfer function and other characteristics for each amplifier through I2C communication. The board has a footprint of 2.4 by 0.7 inches, which is smaller to the current NI DAQ board that is 3.9 by 2.5 inches. The microprocessor can collect analog signals on up to 23 ADC channels. At our design resolution of 16 bits, sampling has a theoretical upper limit of 12 MHz, which for twenty channels can mean up to 600 kHz per channel. The microcontroller is programmable through the standard Arduino IDE with the Teensyduino add-on, and has an internal RAM storage of 192 kB to permit storage of large arrays with digitized readings.

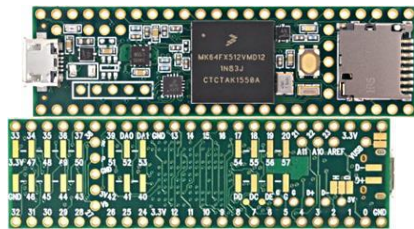

Figure 3: Front and back view of Teensy 3.5 USB board

All amplifiers are of the PGA309 package from National Instruments, as shown in Fig. 4 [5,6]. The purpose of the amplifiers is to increase the sensitivity of the finger sensors. In general, the forces generated by the fingers of the patients induce voltage differences that are too small to analyze on the computer. However, device operators can adjust the gain function of the amplifiers, shown in Fig. 5, through I2C commands to increase the magnitude and offset the voltage difference. The potential gain range of each amplifier is from

2.7 V/V to 1152 V/V, which is achieved through a three-stage amplifier system. The simplified schematic and sensitivity range details of the amplifier subsystem are shown in Fig. 5.

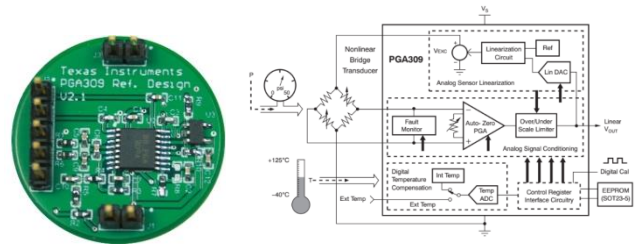
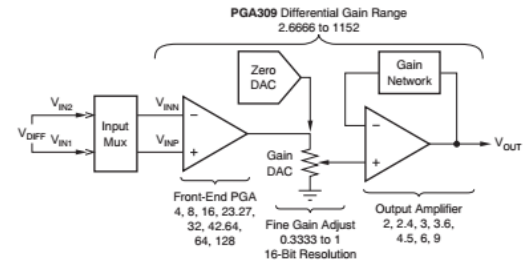

Figure 4: Physical view and simplified block diagram of PGA309 package



NOTE:  $V_{OUT} = [(V_{OFF} + V_{COARSE\ OFFSET}) * (Front-End\ PGA\ Gain) + V_{ZERO\ DAC}] * [Gain\ DAC] * [Output\ Amplifier\ Gain]$

Figure 5: Three-stage amplifier subsystem schematic and gain function

The multiplexers are of the TCA9548A package from National Instruments, as shown in Fig. 6 [7]. The purpose of the multiplexers is to provide address identifiers for each of the amplifiers so that communication from the microprocessor to a given amplifier is possible. By default, the PGA309 package has a fixed I2C address of 0x40, and sending an I2C command on the same data line to all amplifiers will change them all at the same time. Since one of the goals is to provide channel-specific changes to the gain function, the amplifiers need to have addresses assigned from an external device. In this case, the TCA9548A assigns a unique address from 0x00 to 0x07 for up to eight I2C-connected slave devices. Since there are a total of 20 slave amplifiers, the overall DAQ circuit needs a minimum of three multiplexers. The multiplexers themselves each have a hardware-adjustable I2C address from 0x00 to 0x08. As a result, a master device (i.e. the Teensy microcontroller) can access a single amplifier by sending the address of its corresponding multiplexer and the address that its multiplexer assigned it. A visual representation of the device access process is shown in Fig. 7.

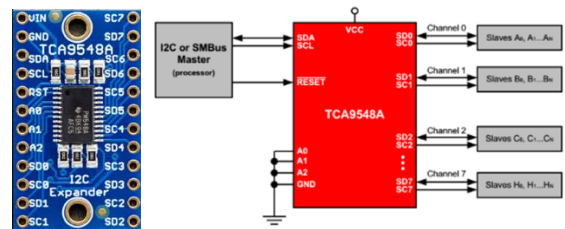

Figure 6: Physical view and simplified block diagram of TCA9548A multiplexer system

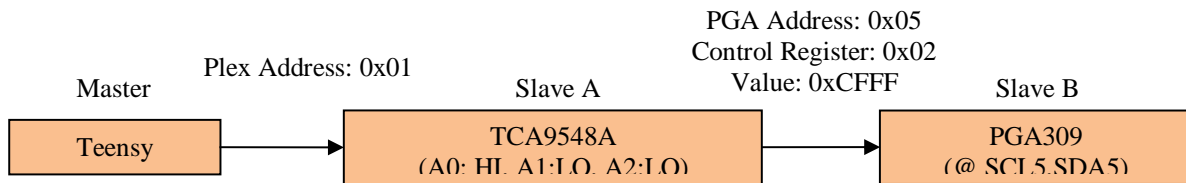

Figure 7: Process flow of accessing amplifier from Teensy through multiplexer

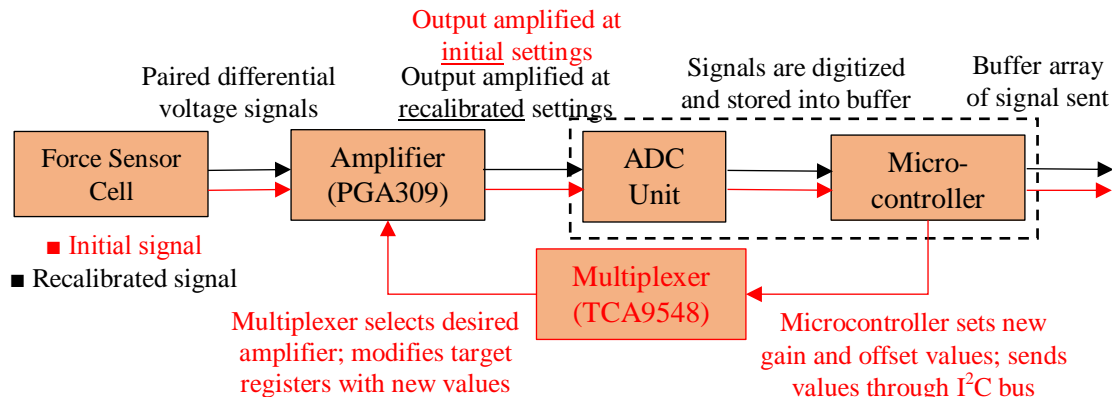

Figure 8: Flow diagram of signal acquisition and recalibration

### III. DATA FLOW COLLECTION

The following process flow for data collection is visualized in Fig. 8. First, the patient applies pressure to the finger sensor boards, which causes the strain gauges to flex. The difference in resistance causes a change in voltage for at least one signal channel. For the input of a given amplifier, two channels from the finger sensor are paired together to represent a coordinate direction of force. The difference between the voltages of the two signals is amplified with initial gain and offset settings. The resulting amplified output signal is sent to the corresponding ADC channel of the Teensy. The voltage is converted to a 16-bit integer, with a reading of 65535 representing the analog reference and upper limit of ~3.3 volts. The digitized readings are then stored into a buffer array for a second before sending the packet over a USB connection to the computer. For the current prototype, sending buffer packets is more reliable than sending continuous stream data, and therefore seems to be a safer option. (We will explore the feasibility of a streaming data version of the device at a later point in time.)

Readings from a particular amplifier can be used in a calibration routine to modify the transfer function of that amplifier to fit desired gain and offset parameters. First, the multiplexer and amplifier addresses are selected by the Teensy for I2C communication to prevent unnecessary writing to multiple amplifiers. Then, a control register address is selected corresponding to the particular characteristic setting that needs to be modified. The value at that address is rewritten to reflect the desired setting. In most cases, this should result in a modified transfer function and, in consequence, better gain sensitivity and offset.

### IV. DESIGN VALIDATION

To ensure that the data acquisition board was going to function as expected when fabricated, a prototype was developed through a wired breadboard setup, as shown in Fig. 9. The breadboard features the Teensy microcontroller, two PGA309 amplifiers, a TCA95488 multiplexer, a 0.5 mm FPC pitch connector for finger board attachment, and multiple buttons for debug routines. A library of functions, tentatively named “pga\_i2c”, was developed for the Teensy to interface with the multiplexers and amplifiers. Using the updated Teensy Wire and ADC libraries as dependencies, routines were developed for switched between multiplexer addresses, between multiplexer-assigned amplifier addresses, between read and write modes, and between the different control register addresses for accessing amplifier settings. Routines were also developed for collecting a stream of analog readings through up to 20 ADC channels and for sending a buffer of readings over USB.

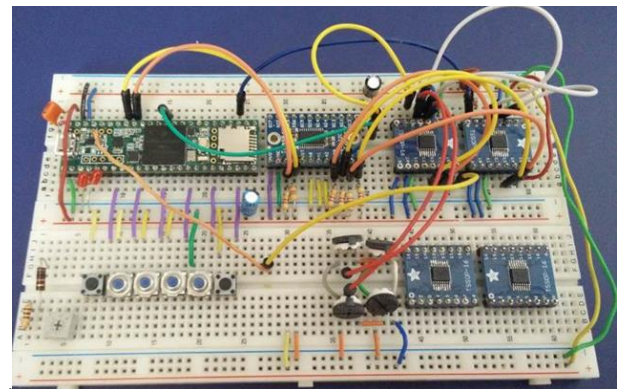

Figure 9: Breadboard mockup prototype of data acquisition board

$V_{ref}$	$V_{offset,fine}$	$V_{offset,coarse}$	GI	GD	GO	$V_{diff,abs}$	$V_{out,multimeter}$	$V_{out,ADC}$	$V_{out,calc}$	%error <sub>ADC</sub>	%error <sub>calc</sub>
3.27	0.82	0	4	0.5	2	0.29	2	2.01	1.98	0.29	-1.13
3.27	1.64	0	4	0.5	2	0.29	2.82	2.82	2.80	-0.03	-0.89
3.27	0.82	0	4	0.33	2	0.29	1.33	1.33	1.31	0.17	-1.87
3.27	0.82	0	4	1	2	0.11	2.49	2.50	2.52	0.39	1.00
3.27	0.82	-0.014	4	0.5	2	0.29	2	2.01	1.92	0.29	-3.90
3.27	0.82	0	8	0.5	2	0.26	2.75	2.75	2.90	0.16	5.36
3.27	0.82	0	4	0.5	3	0.26	2.68	2.68	2.79	0.16	3.96
3.27	0.82	0	16	0.5	2	0.07	1.89	1.90	1.94	0.32	2.51
3.27	0.82	0	4	0.5	2.4	0.07	1.33	1.31	1.32	-1.71	-0.98

Table 1: Results summary of amplifier setting change test

Averaging Samples	Sampling Speed	Conversion Speed	Sampling Rate (kHz)	Average noise (increments)
8	Medium	Medium	26.56	30
16	Medium	Medium	14.23	25
16	High	High	28.29	29

Table 2: Summary of trials conducted to quantify noise and sampling rate

To filter out high frequency noise above 1000 Hz, a passive low-pass RC filter with a cutoff frequency of 100 Hz was wired using a 100nF capacitor and a 16k $\Omega$  resistor. It should be noted that this filter design was only a simple implementation to filter noise above the Nyquist frequency; a better filter implementation will be explored in the next version. The output was sent back to the feedback port of the amplifier for proper amplifier operation and for signal stability.

After selecting the appropriate resistors for I2C communication and capacitors for decoupling and filtering, a validation test was done using the breadboard mockup to verify that changes to the PGA309 settings were reflected in modified output analog signals. Table 1 and Appendix C together state the setting changes for each trial, which can include gains for all three internal amplifiers (GI, GD, GO), and ratios for both coarse and fine offset. The table and appendix together also include the input signal voltage, the output voltage before and after digitization, and the output voltage predicted by the transfer function. The ADC did not appear to affect the voltage of the raw analog signal, since the error was at most 0.39% except for the last trial with an error of 1.71%. The transfer function also predicts the raw analog signal with a maximum error margin of 5.36% across all nine trials.

Afterwards, a performance study was conducted to gauge the sampling speed of the microcontroller. This involved modifying the ADC settings provided with the ADC library. Sampling and conversion speed were each changed through generic terms (i.e. “very low”, “low”, “medium”, “high”, “very high”). Output resolution and averaging interval were changed through numeric settings (the actual reading size was still 16 bits per sample, so packet size could not be reduced in size). The results are summarized in Table 2 and shown in full on Appendix D. For the purposes of minimizing noise while

keeping the sampling rate over at least 1 kHz per channel, the maximum averaging interval and resolution of 16 each should be selected with both speed settings set to high. (For 16-bit resolution, the performance of “very high” speed for both speed settings is equivalent to “high” speed.)

Another test was conducted to see the maximum noise being generated for an analog reading when no force input was applied to sensors. The target noiseless resolution for a given analog reading is at least 12 bits out of the 16 available bits. This is equivalent to having a maximum noise margin of 16 on the digitized reading. A sample ADC reading with approximate noise envelope is given in Fig. 10. Noise was approximated by estimating the largest magnitude between an adjacent peak-trough pair in the signal. Due to limitations of the Serial Plotter interface on the Arduino IDE, only the last 500 samples of a continuous data stream are plotted at a given time, and data could not be exported from the Serial Plotter for analysis. Therefore, evaluation of noise could be conducted only on the last 500 samples. Based on findings summarized in Table 2, it seems that the breadboard prototype yields 5 bits of noise and can only provide up to 11 bits of noiseless data. Part of the noise could be attributed to internal error inside the ADC unit(s) or from the long wiring used to operate the breadboard circuit; the analog reading waveforms suggest that EM noise from external sources did not have a significant contribution, although it has not entirely been ruled out.

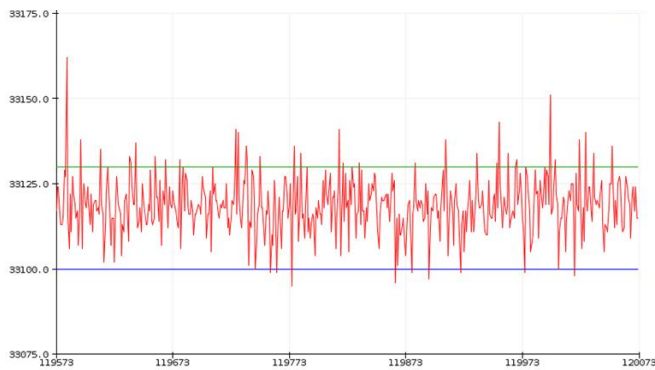

Figure 10: Digitized 16-bit voltage readings in red of third trial at last 500 samples; lines used to control upper and lower axis limits for voltage are in green and blue

## V. PCB DESIGN

With the circuit design validated in the breadboard prototype, a PCB implementation is now desirable. Printed circuit boards have cleaner and shorter wiring that will reduce noise, a smaller footprint that will allow physical placement into the Hand Device, will allow for efficient placement of all multiplexers and amplifiers within the DAQ subsystem, and will be a much safer implementation for all users in terms of electrical exposure.

The final PCB design, shown in Appendix B, is a four-layer mixed-signal design with trace wiring on the layer 1 (the upper layer) used mostly for sending 3.3 V power and reference, the digital ground pour plane on layer 2 (the layer underneath), the analog ground pour plane on layer 3, and mostly communication connections involving I2C and raw analog readings on layer 4 (the bottom layer). The multiplexers and amplifiers are surface-mount (SMT) packages that can be soldered directly to pads on layer 1, whereas the Teensy board can interface with layer 1 through soldered header connections. Using header pin/socket connections will make it easy to insert and remove the Teensy unit from the rest of the PCB. The remaining capacitors, resistors, and finger interface pin connectors are also SMT components that can be soldered to layer 1.

The noise found in the validation phase may decrease from having large ground planes act as shielding for the PCB circuit, having shorter copper traces for wiring, and having external shielding on the inner wall of the Hand Device's mechanical housing.

## VI. SIGNIFICANCE AND GOING FORWARD

The aforementioned custom DAQ board provides the necessary amount of independent analog channels needed to

sense three-dimensional forces from the user's fingers fitted into the Stroke Rehabilitation Hand Device. From the validation tests, modifying the gain function works as intended and the noise is manageable. The basic DAQ design is validated on breadboard and can be translated to a more refined PCB deliverable.

From here, the group can expect to have the PCB design fabricated at a third-party vendor within the next couple of weeks and attached to the overall Hand Device soon after. Once fully assembled with revised mechanical features (i.e. faster and easier attachment mechanisms for patients and a more comfortable thumb interface), the Hand Device is planned to undergo holistic validation for healthy and chronic patients at Western University in Canada, and for acute patients within the Johns Hopkins Department of Neurology. If said validation passes, the Stroke Rehabilitation Hand Device should be a suitable candidate for tracking and guiding the improvement of hand control of stroke patients. This in turn should lead to better recovery in both the short and long term and result in a higher quality of life for patients.

## ACKNOWLEDGMENT

We would like to thank Dr. Russell Taylor, Alexis Cheng, and Dr. John Krakauer for their support throughout the project.

## REFERENCES

- [1] J. Xu, N. Ejaz, B. Hertler, M. Branscheidt, M. Widmer, A. Faria, M. Harran, J. Cortes, N. Kim, P. Celnik, T. Kitago, A. Luft, J. Krakauer and J. Diedrichsen, "Recovery of hand function after stroke: separable systems for finger strength and control," *bioRxiv*, 2016.
- [2] Olds, K. (n.d.). "System for Hand Rehabilitation" [Disclosure document]. Retrieved February 20, 2017.
- [3] PJRC. (n.d.). Teensy USB Development Board. Retrieved March 07, 2017, from <https://www.pjrc.com/teensy/index.html>.
- [4] S. Ito, H. Kawasaki, Y. Ishigure, Y. Nishimoto, T. Aoki, T. Mouri, H. Sakaeda and M. Abe, "Development of a Hand Motion Assist Robot for Rehabilitation Therapy by Patient Self-Motion Control," in *Proceedings of the 2007 IEEE 10th International Conference on Rehabilitation Robotics*, Noordwijk, Netherlands, 2007.
- [5] Texas Instruments. (2011, January). "PGA309: Voltage Output Programmable Sensor Conditioner" [Data file and code book]. Retrieved March 07, 2017, from <http://www.ti.com/lit/ds/symlink/pga309.pdf>.
- [6] Texas Instruments. (2011, January). "PGA309: Voltage Output Programmable Sensor Conditioner User's Guide" [Data file and code book]. Retrieved March 07, 2017, from <http://www.ti.com/lit/ug/sbou024b/sbou024b.pdf>.
- [7] Texas Instruments. (2012, May). "TCA9548A Low-Voltage 8-Channel I<sup>2</sup>C Switch with Reset" [Data file and code book]. Retrieved April 15, 2017, from <http://www.ti.com/lit/ds/symlink/tca9548a.pdf>.

## Management Summary

Originally, the planned objectives of this hand rehabilitation project was to conduct a patient study with the original hand rehabilitation prototype after getting approval from the IRB and clinical engineering team at Johns Hopkins Hospital. Due to new developments regarding an upcoming rehabilitation study on chronic stroke patients at Western University in Canada that will use the prototype, the initiative to get an initial clinical study performed was canceled.

There was also a plan to develop new mechanical features of the prototype, which included a revised mechanism for attaching and removing the arm brace quicker, a new finger interface for the thumb digit, and a mechanism for attaching the finger cups that did not involve full screw rotations. The intent of these improvements was to make the device more accessible for patients to use independently in a home environment. Initially, I developed alternative design CAD models for each mechanical feature and met with my mentor in several brainstorm sessions to refine or propose ideas. Ultimately with news of the new deadline for the Canada study, my mentor decided to assume responsibility of finishing the mechanical design and fabrication. At the time of this writing, he had the arm brace attachment mechanism fully fabricated, the finger cup attachment mechanism fully modeled and being fabricated off-site, and had finished revising the silicone mold model for the thumb finger cup.

Throughout the semester, I was in charge of designing and prototyping the new data acquisition board for the hand rehabilitation device. A functional prototype, a schematic, and a corresponding PCB board design were developed. From my extensive work on the DAQ subsystem, I learned that developing and troubleshooting circuits of this scale require much more time than anticipated. In particular, the design phase of the PCB board took several revisions over the course of a month, with a majority of issues arising from trace placement conflict or violated design rules. Ultimately, I have learned a lot about mixed-signal design and PCB manufacturing beyond the breadboard prototype phase. At present, the PCB board designs are being sent to a third-party manufacturer (Advanced Circuits) for fabrication and assembly.

Finally, there was a plan to conduct a second clinical study that involved the revised prototype, but that has been put on hold due to the deadline timing introduced by the Canada study. The Department of Neurology may conduct a separate in-house study targeted at acute stroke patients at some point in the next several months, but the exact date is undetermined.

Over the summer and into fall, my mentor and I are planning to receive the fabricated DAQ boards from the third-party manufacturer, and have the mechanical features of the hand rehabilitation device fully fabricated and implemented. After all proposed features are implemented on at least two copies of the new prototype, the devices will be sent over to Western University where they will begin to perform independent evaluation of the device with healthy participants and chronic patients. This is under the assumption that the corresponding grant for their study is approved; the grant is still pending approval at the time of this writing.

Appendix A: Board Schematic (larger image on Wiki site)

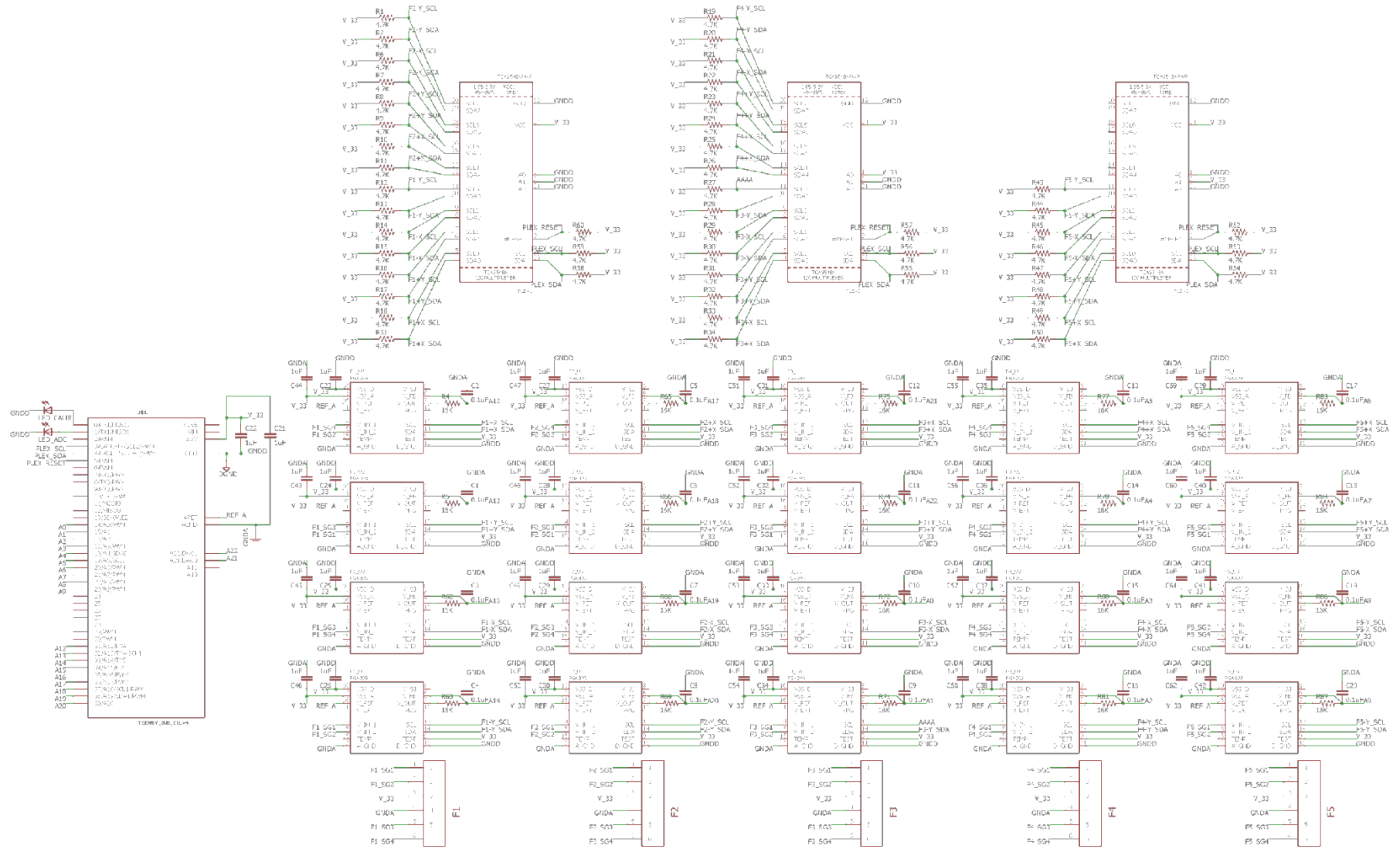

Appendix B: Board Trace and Component Placement Views

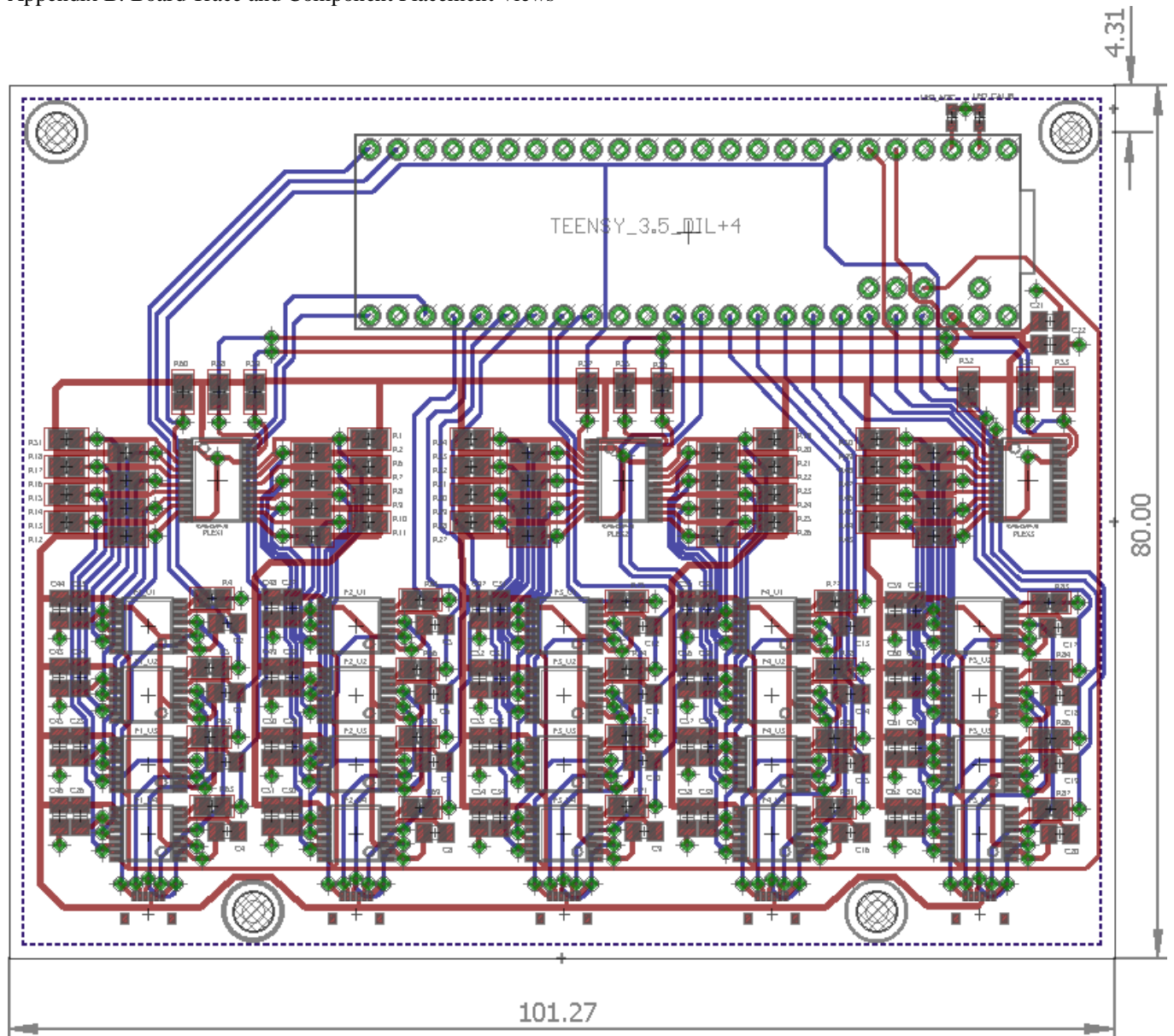

Figure B1: Overall view of PCB layout (ground layers hidden)



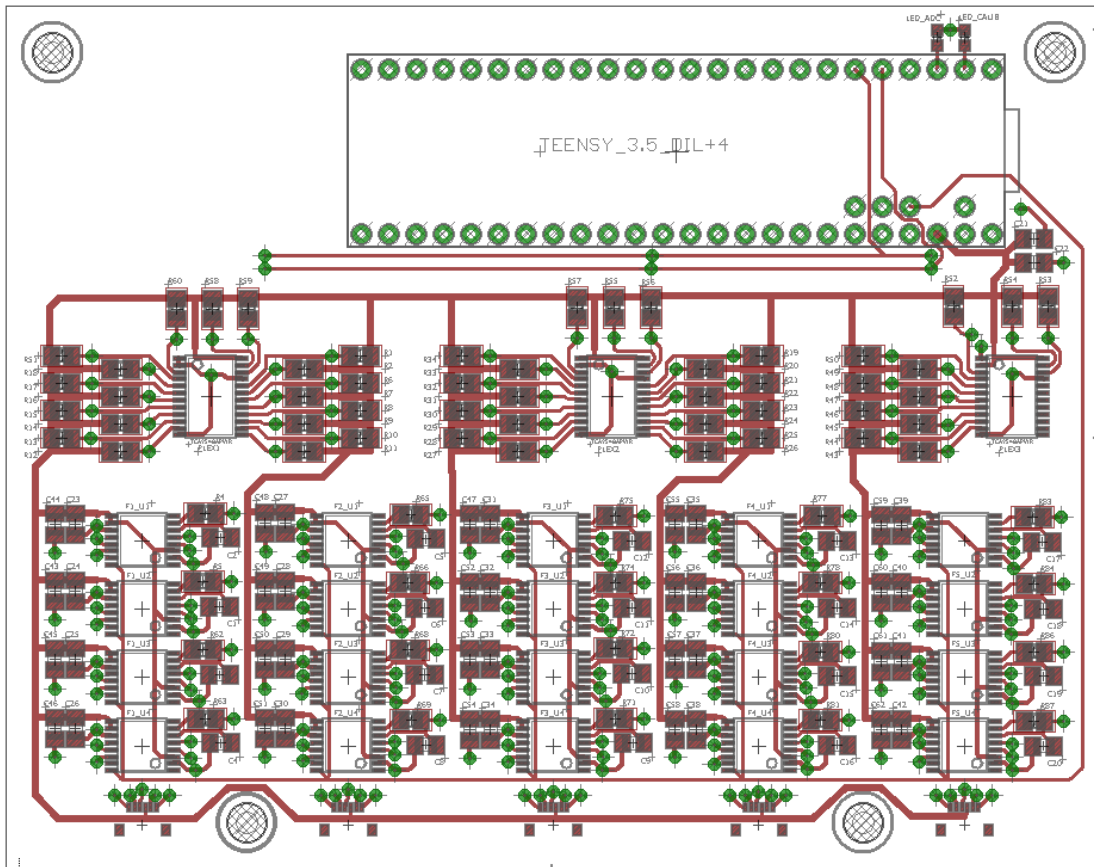

Figure B2: Layer 1 (Top)

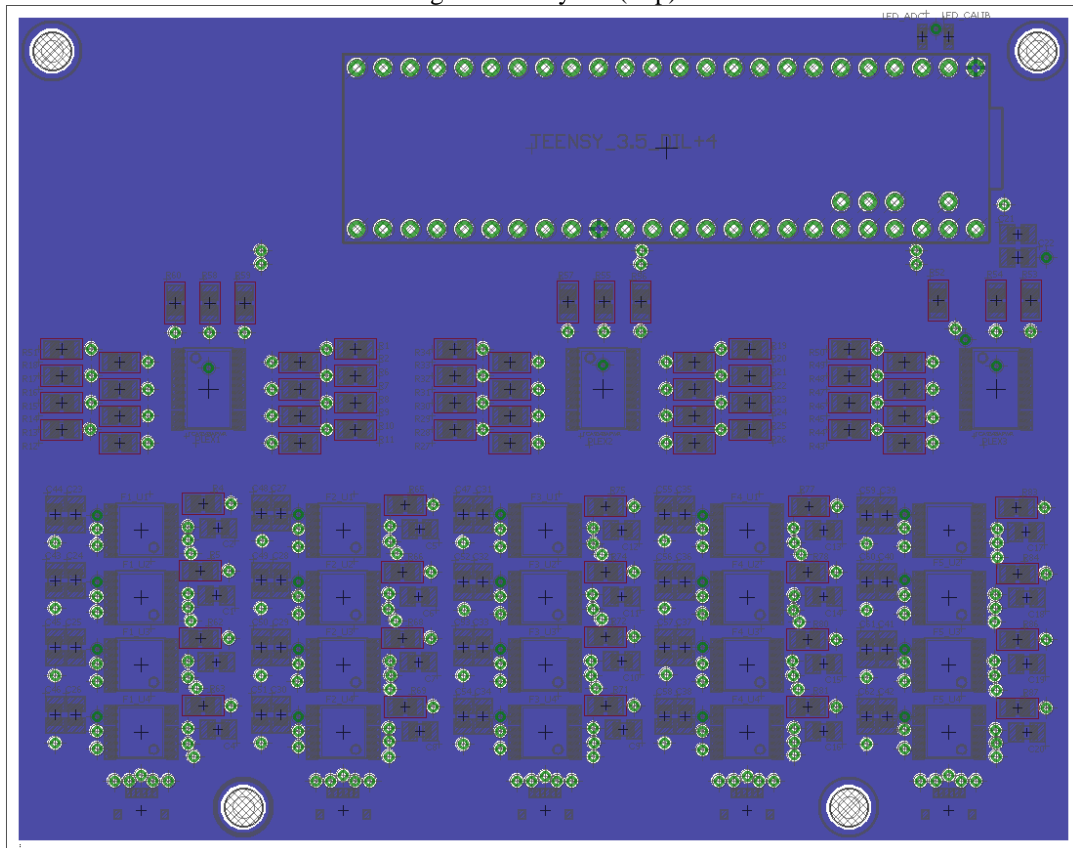

Figure B3: Layer 2 (Digital Ground)

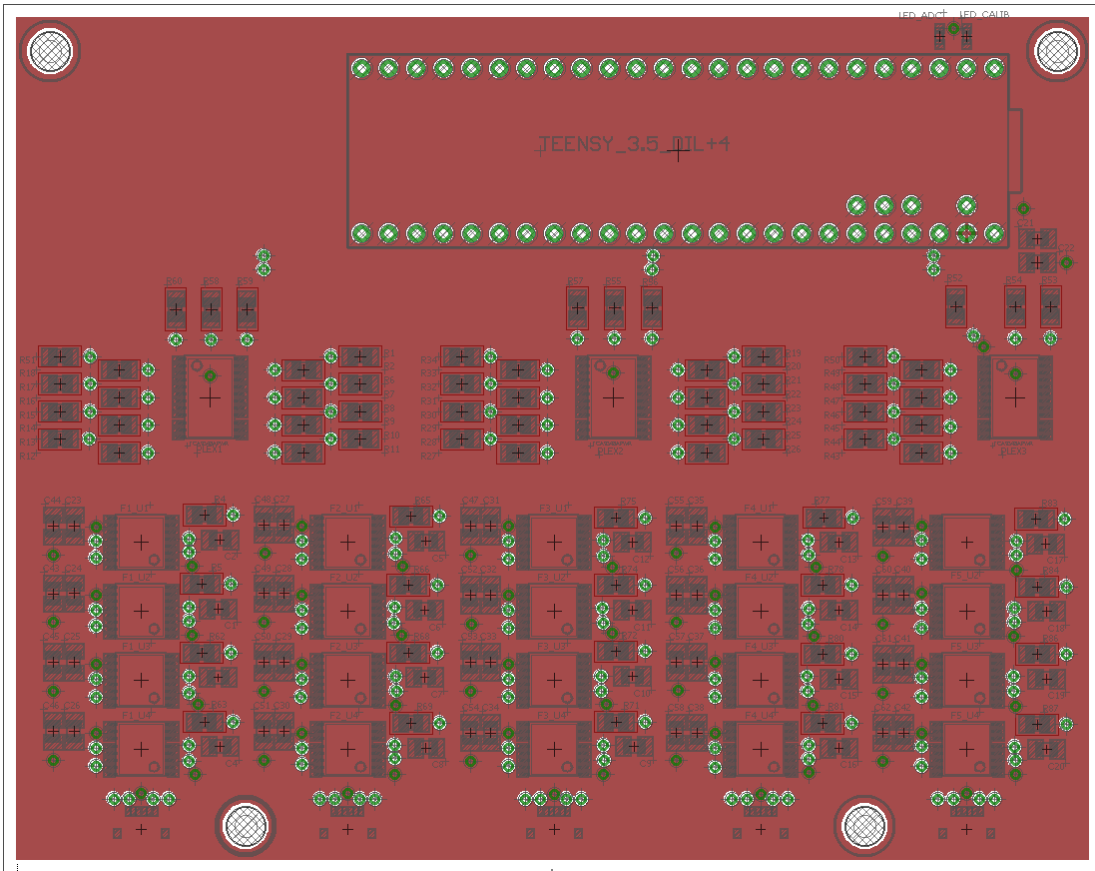

Figure B4: Layer 3 (Analog Ground)

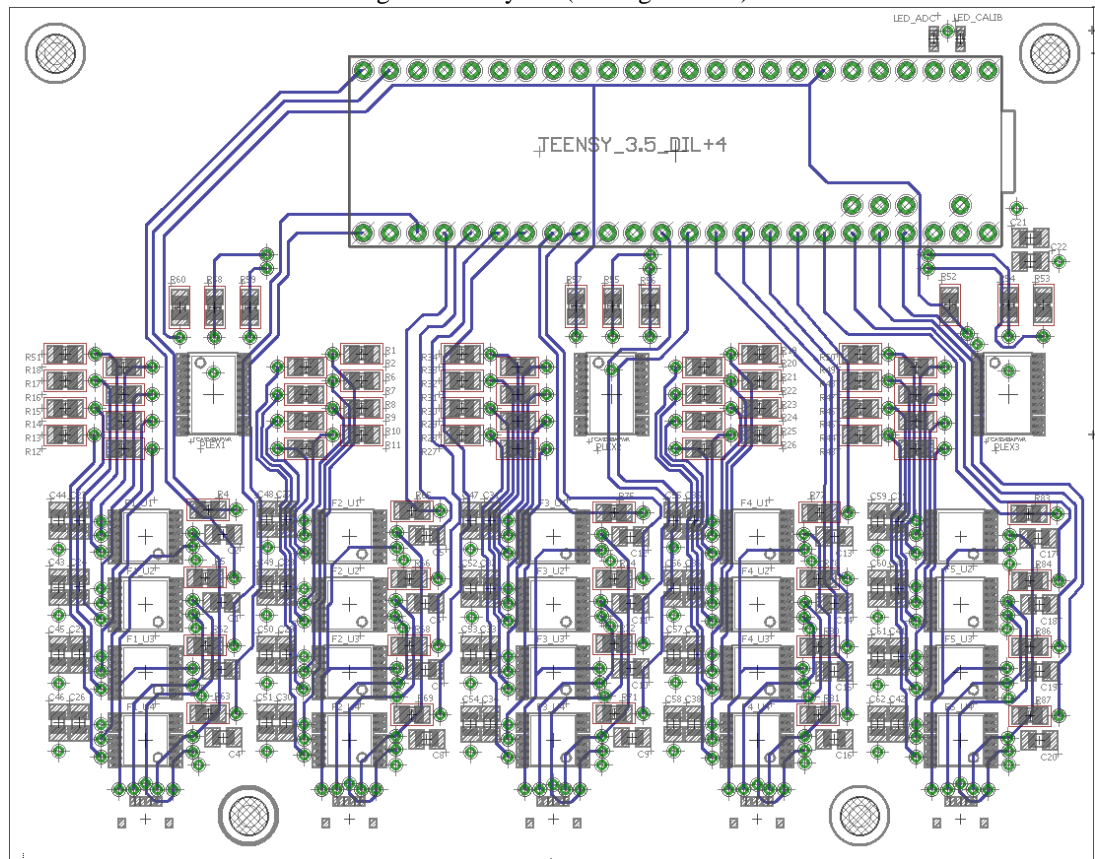

Figure B5: Layer 4 (Bottom)

Appendix C: Full Results from PGA Setting Changes

$V_{ref}$	$V_{offset, fine, ratio}$	$V_{offset, fine}$	$V_{offset, coarse, ratio}$	$V_{offset, coarse}$	G	GD	G	$V_{in,1}$	$V_{in,2}$	$V_{diff, abs}$	$V_{out, probe}$	ADC <sub>reading</sub>	$V_{out, AD}$	$V_{out, calc}$	%error <sub>AD</sub>	%error <sub>calc</sub>
3.2 7	0.25	0.82	0	0	4	0.5	2	1.0 5	0.7 6	0.29	2	40200	2.01	1.98	0.29	-1.125
3.2 7	0.5	1.64	0	0	4	0.5	2	1.0 5	0.7 6	0.29	2.82	56500	2.82	2.80	-0.03	-0.89
3.2 7	0.25	0.82	0	0	4	0.3 3	2	1.0 5	0.7 6	0.29	1.33	26700	1.33	1.30	0.17	-1.87
3.2 7	0.25	0.82	0	0	4	1	2	1.3 3	1.2 2	0.11	2.49	50100	2.50	2.52	0.39	1.00
3.2 7	0.25	0.82	-5	-0.014	4	0.5	2	0.7 5	0.4 6	0.29	2	40200	2.01	1.92	0.29	-3.90
3.2 7	0.25	0.82	0	0	8	0.5	2	2.1 5	1.8 9	0.26	2.75	55200	2.75	2.90	0.16	5.36
3.2 7	0.25	0.82	0	0	4	0.5	3	2.1 5	1.8 9	0.26	2.68	53800	2.68	2.79	0.16	3.96
3.2 7	0.25	0.82	0	0	16	0.5	2	1.9 6	1.8 9	0.07	1.89	38000	1.90	1.94	0.32	2.51
3.2 7	0.25	0.82	0	0	4	0.5	2.4	1.9 6	1.8 9	0.07	1.33	26200	1.31	1.32	-1.71	-0.98

Appendix D: Full Results from Adjusting ADC Settings

Sampling Speed	Conversion Speed	Buffer Size (integers)	Resolution (bits)	Averaging interval (samples)	Sampling period (ms)	Sampling rate (kHz)
Medium	Medium	20000	16	8	756	26.46
Medium	Medium	40000	16	4	858	46.62
Medium	Medium	40000	16	8	>1000*	< 40.00*
High	High	20000	16	4	383	52.22
Very low	Very low	20000	16	4	>1000*	< 20.00*
Very low	Very low	20000	16	0	336	59.52
Slow	Slow	20000	16	0	289	69.20
Slow	Slow	20000	12	0	263	76.05
Medium	Medium	20000	12	0	150	133.33
Very high	Very high	20000	12	0	103	194.17
High	High	20000	12	0	103	194.17
Medium	Medium	20000	16	16	1405	14.23
High	High	20000	16	16	707	28.29

Appendix E: pga\_i2c library (.ino file on Wiki site)

Appendix F: PGA309 Datasheet (.pdf file on Wiki site)

Appendix G: PGA309 User's Guide (.pdf file on Wiki site)

Appendix H: TCA95488 User's Guide (.pdf file on Wiki site)

Appendix I: All ADC Reading Graphs Generated for Noise Measurement  
(x-axis is samples since start of ADC collection; y-axis is digitized 16-bit voltage reading)  
(predicted upper axis limit in green, predicted lower axis limit in blue, output reading in red)

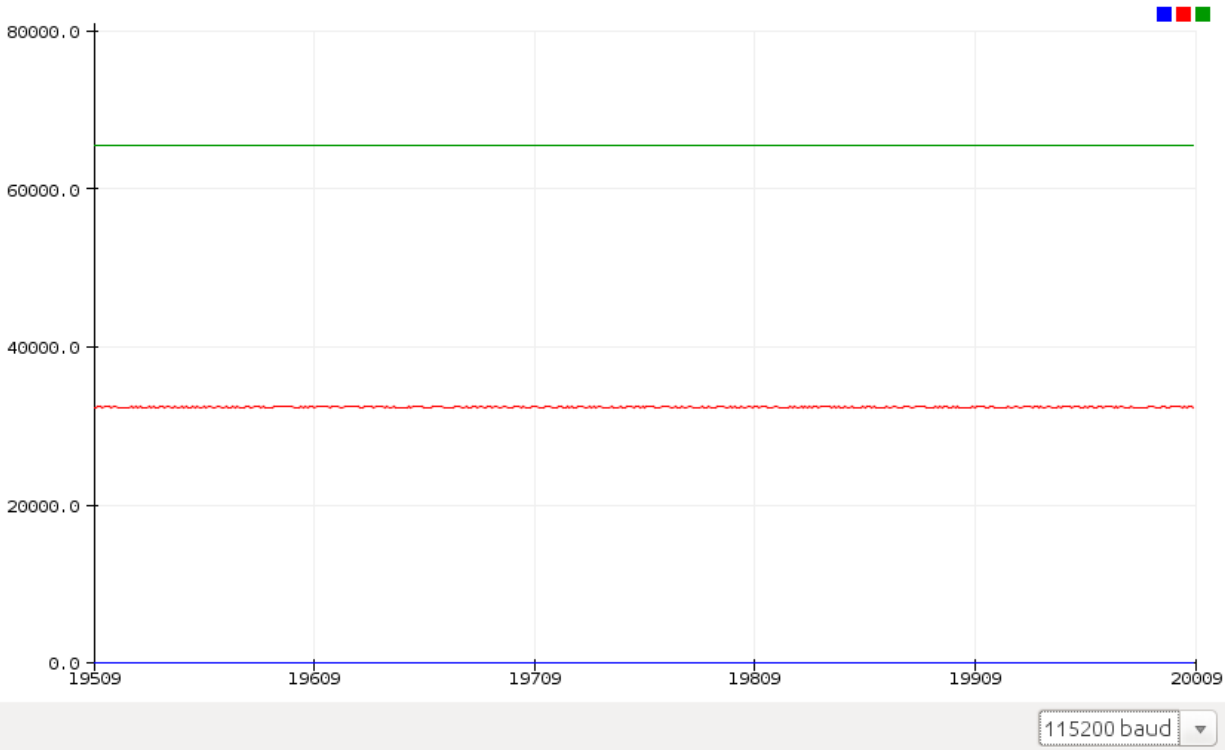

Figure I1: Offset in transfer function set such that zero reading is roughly equivalent to 50% of reference voltage

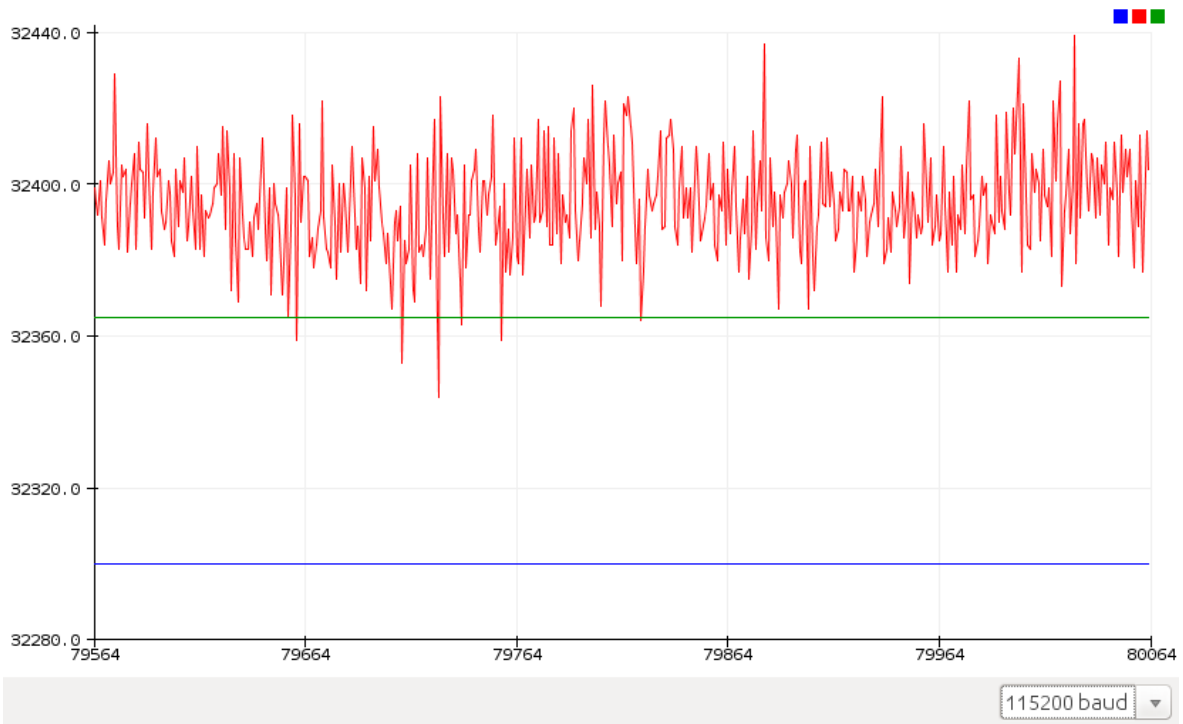

Figure I2: Typical zoomed-in view from zero reading graph with offset (0 averaging);

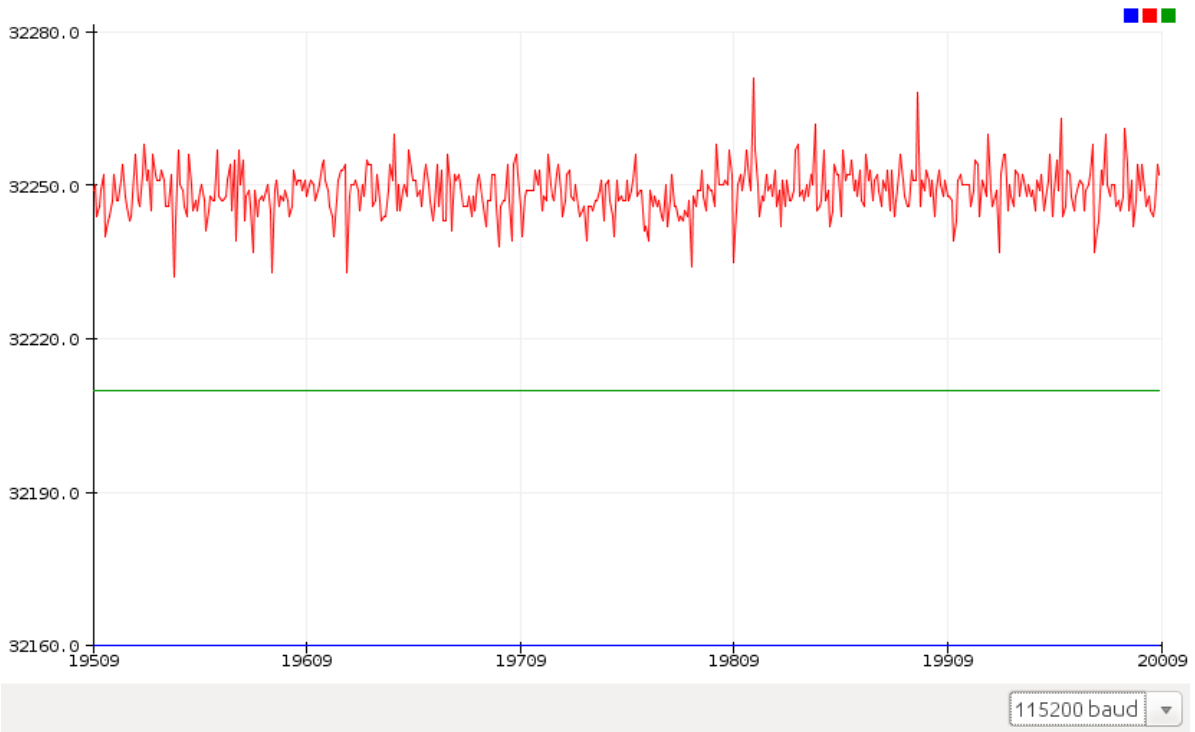

Figure I3: 16-sample averaging; high sampling speed; high conversion speed

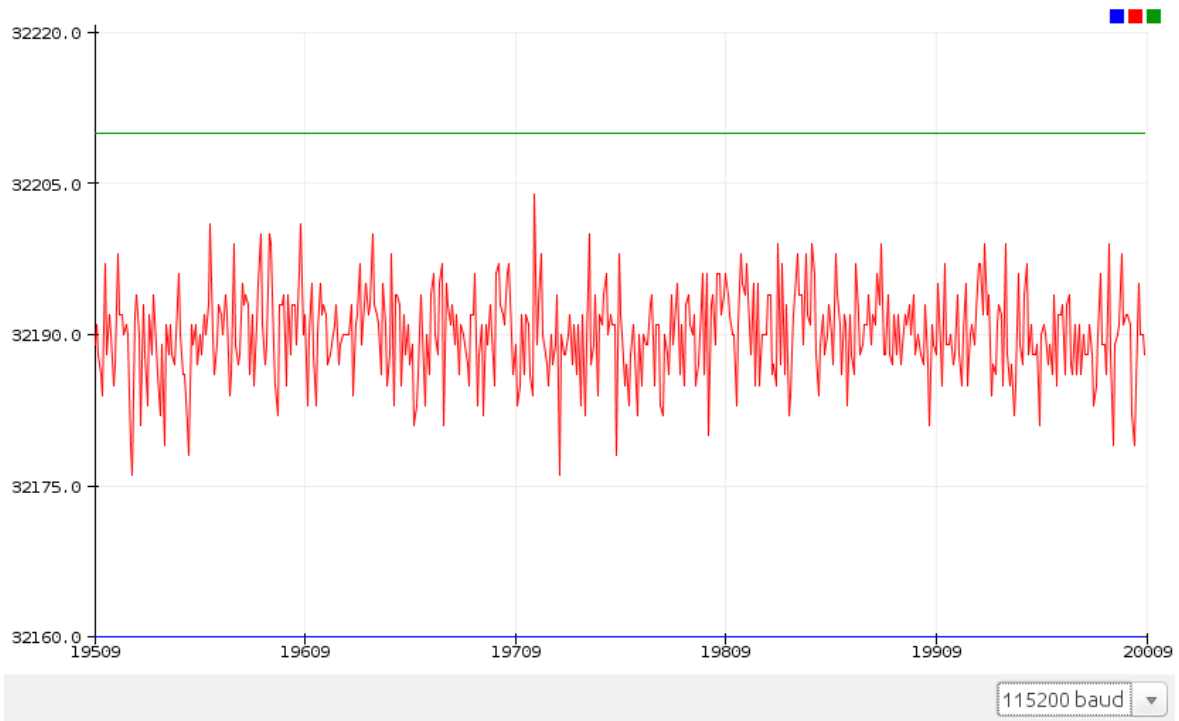

Figure I4: 16-sample averaging; medium sampling speed; medium conversion

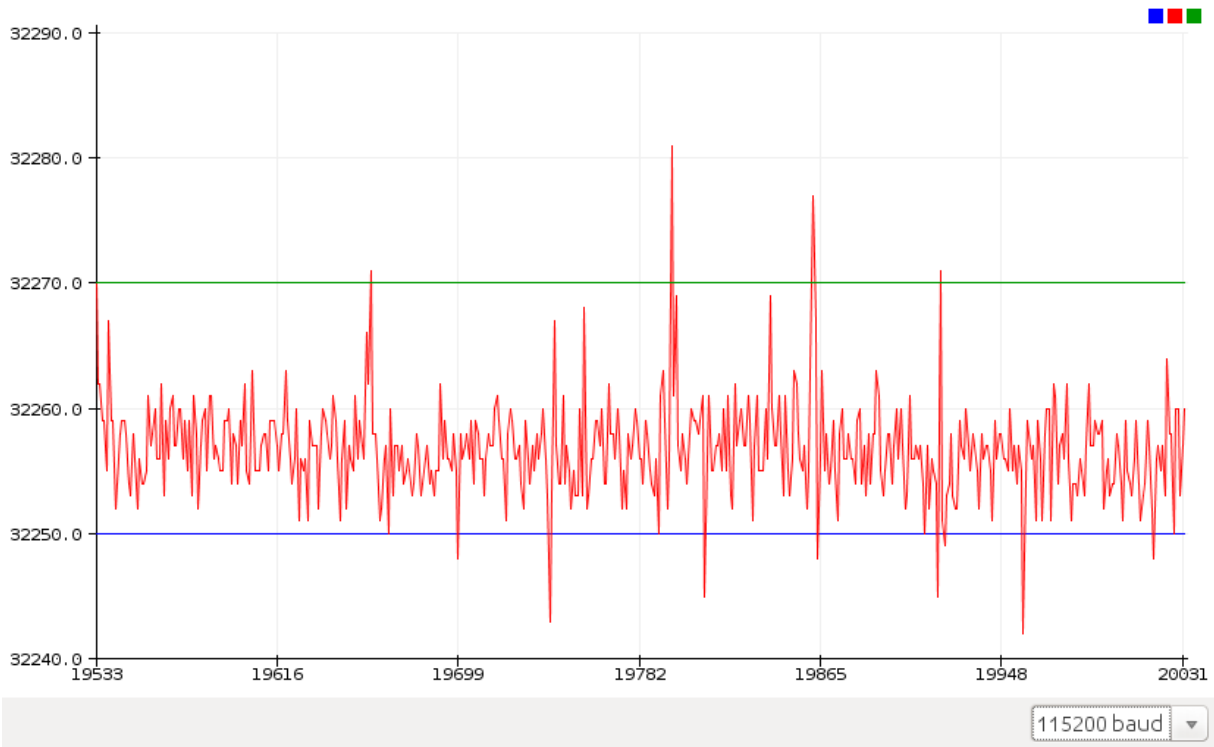

Figure I5: 32-sample averaging; high sampling speed; high conversion speed



Figure I6: 8-sample averaging; medium sampling speed; medium conversion speed

The following graphs were recorded much earlier, but provided little value for selecting optimal settings due to visual indication that noise seemed higher. Analysis also provided hard since graphs are zoomed out and incorporated an earlier implementation of the LP filter, so comparison would have little meaning.



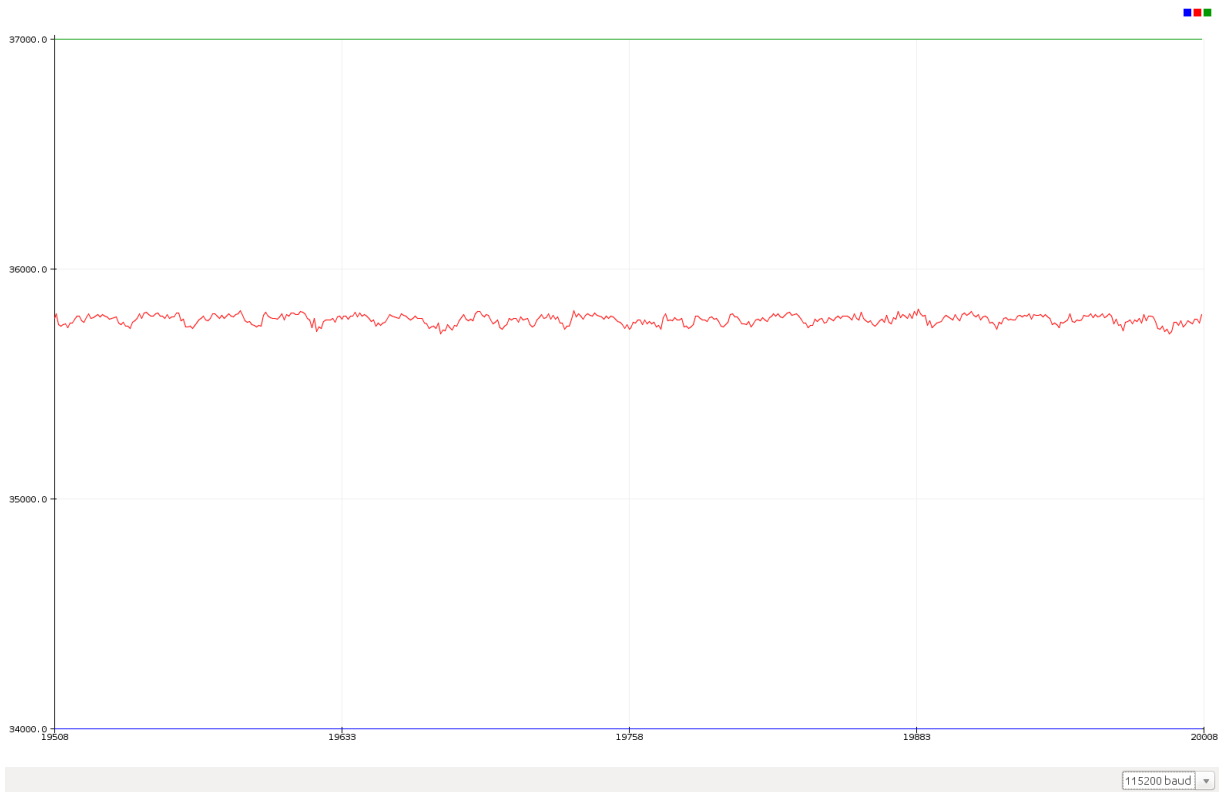

Figure I7: 4-sample averaging; slow sampling speed; slow conversion rate

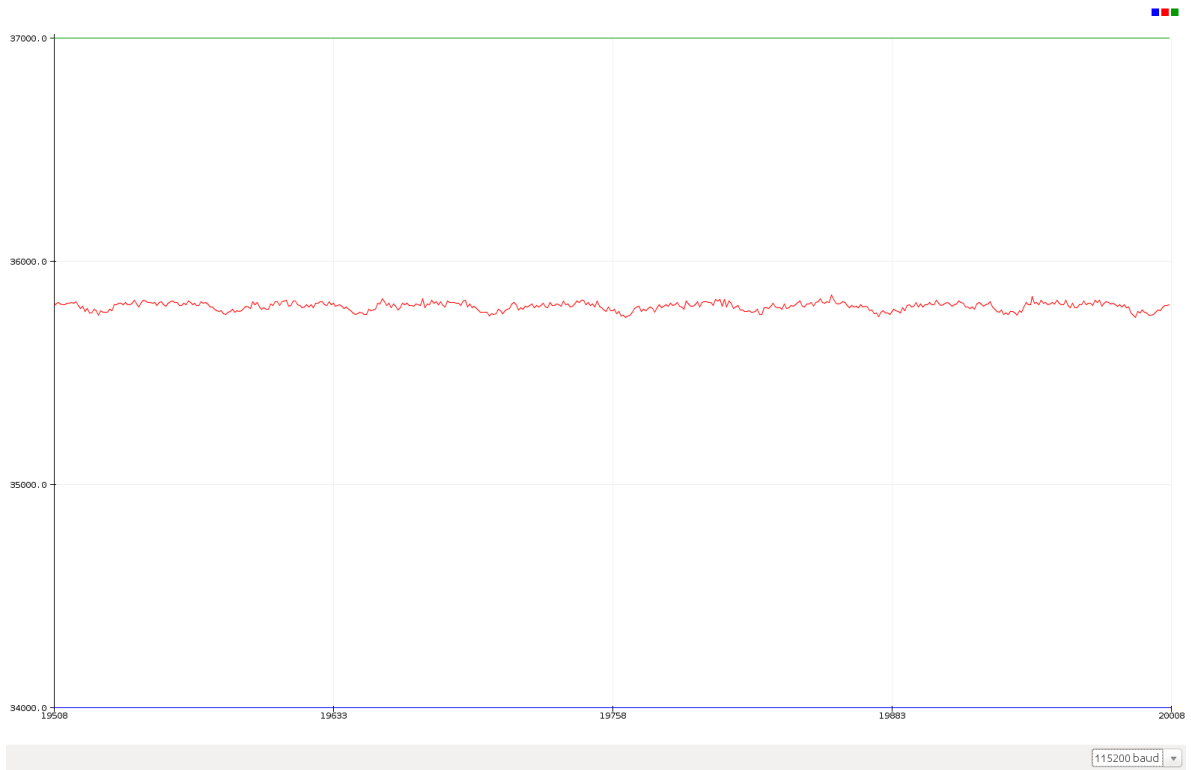

Figure I8: 4-sample averaging; medium sampling speed; medium conversion speed

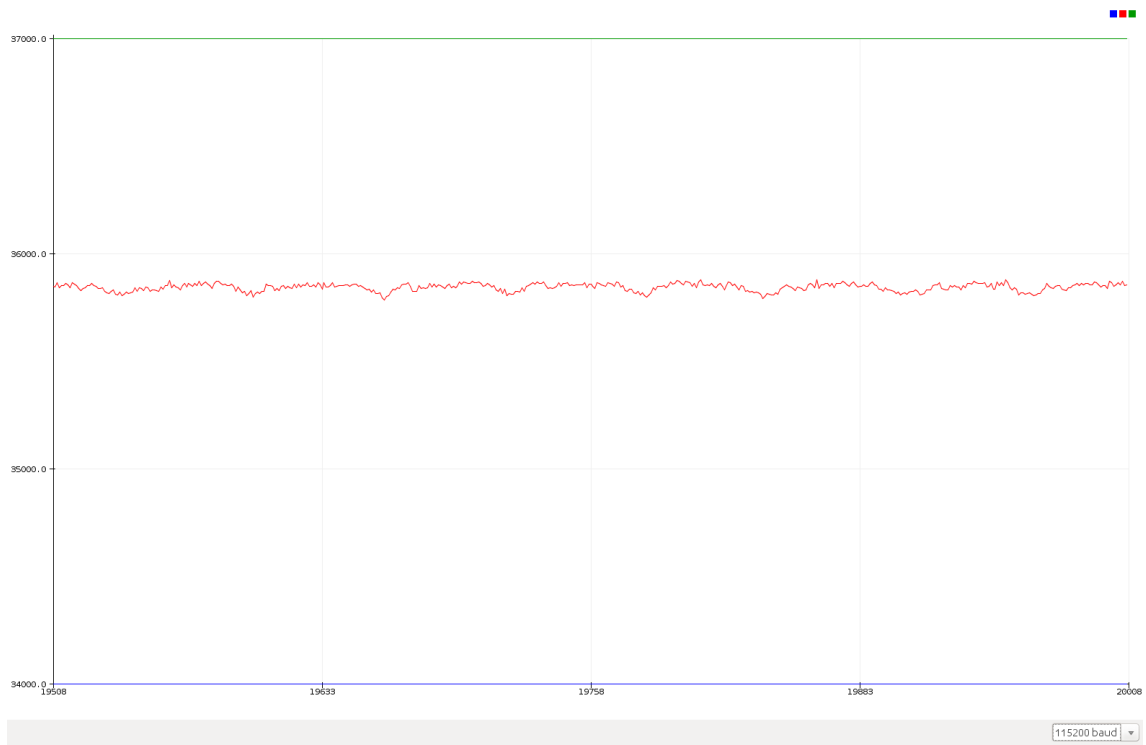
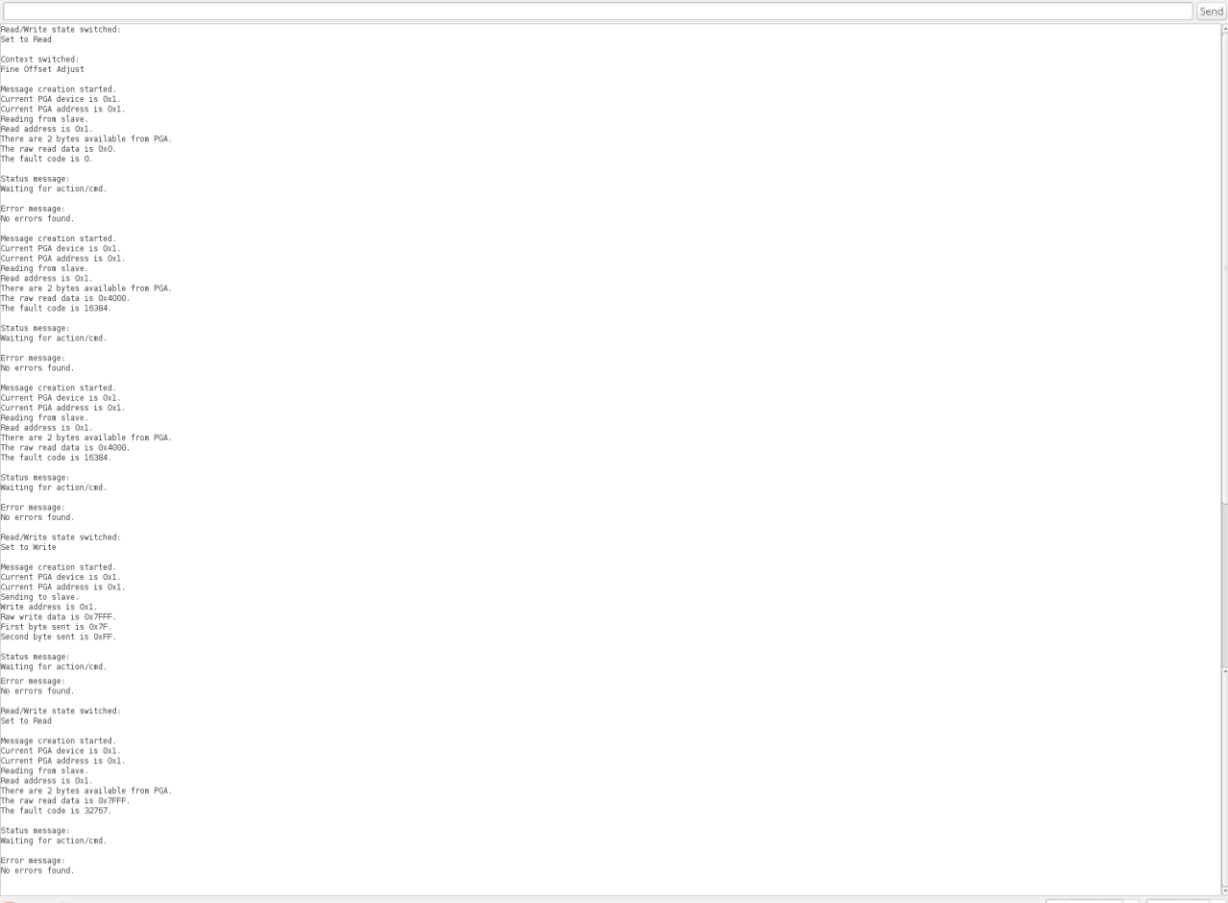

Figure I9: 8-sample averaging; high sampling speed; high conversion speed

## Appendix J: Sample data collection output for pga\_i2c library in Serial Monitor



```
Read/Write state switched:
Set to Read
Context switched:
Fine Offset Adjust
Message creation started.
Current PGA device is 0x1.
Current PGA address is 0x1.
Reading from slave.
Read address is 0x1.
There are 2 bytes available from PGA.
The raw read data is 0x0.
The fault code is 0.
Status message:
Waiting for action/cad.
Error message:
No errors found.
Message creation started.
Current PGA device is 0x1.
Current PGA address is 0x1.
Reading from slave.
Read address is 0x1.
There are 2 bytes available from PGA.
The raw read data is 0x4000.
The fault code is 16384.
Status message:
Waiting for action/cad.
Error message:
No errors found.
Message creation started.
Current PGA device is 0x1.
Current PGA address is 0x1.
Reading from slave.
Read address is 0x1.
There are 2 bytes available from PGA.
The raw read data is 0x4000.
The fault code is 16384.
Status message:
Waiting for action/cad.
Error message:
No errors found.
Read/Write state switched:
Set to write
Message creation started.
Current PGA device is 0x1.
Current PGA address is 0x1.
Sending to slave.
Write address is 0x1.
Raw write data is 0x7FFF.
First byte sent is 0x7F.
Second byte sent is 0xFF.
Status message:
Waiting for action/cad.
Error message:
No errors found.
Read/Write state switched:
Set to Read
Message creation started.
Current PGA device is 0x1.
Current PGA address is 0x1.
Reading from slave.
Read address is 0x1.
There are 2 bytes available from PGA.
The raw read data is 0x7FFF.
The fault code is 32767.
Status message:
Waiting for action/cad.
Error message:
No errors found.
```

Autoscroll No line ending | 115200 baud

Figure J1: Output defined by pga\_i2c library as PGA is being accessed and having a register's value changed

Appendix K: Mentor Questionnaire – Project # 15

**10/10 Overall project and progress**

- Were you satisfied with the overall technical progress made in the course of the semester? **Yes**
- Was the total accomplishment appropriate for the number and level (undergrad/graduate) of students on the project? **Yes**
- Will the results be useful to you in the future? **Definitely, we will use these results for a future clinical study, publications, and grant applications.**
- Do you see a prospect for patents or publication to result? **Patents have already been filed, and publications will follow shortly.**

**10/10 Report (which the students should have shared with you)**

- Does the project report accurately reflect the scope and accomplishment of the project? **Yes**
- Were you given an adequate opportunity to review the report?  
**Yes**
- Does the report and its appendices, together with the web site, provide sufficient information that subsequent groups can make effective use of the project results.  
**Yes**
- In particular, are any project designs or code adequately documented?  
**Yes, the design files and code are all archived and well documented.**

**10/10 Web site**

- Does the web site reflect the scope and accomplishment of the project?  
**Yes**
- Do you wish the web site to remain password protected after May 30? If so, for how long?  
**Yes, for 6 months until the publication is submitted and all of the IP is filed.**

**9/10 Management**

- Were the students fully engaged in the project? **Yes**
- How often did they meet with you? **Once per week at least** Was this enough? **Yes**
- Were the “deliverables” and “dependencies” realistic?  
**Mostly, we are a little behind schedule, but it looks like we will be within a week or two of the planned completion date.**
- Was the plan realistic? Were unmet dependencies approached in an effective manner?  
**Yes, we planned ahead of time to adjust the IRB and CES deliverables as needed. Because of the sudden prospect of the collaboration with Western University, we adjusted the plan accordingly and focused on the technical deliverables.**

**Other comments or suggestions**

- Do you have any other comments or suggestions, either about the specific project or about the overall structure of the course for next year.