

# ***Robot Control Algorithms Based on Sclera Force Information***

## ***Project Checkpoint Presentation***

*By Ali Ebrahimi, Group 7*

*Mentors: Prof. Marin Kobilarov, Prof. Iulian Iordachita, Prof. Russell Taylor  
and Dr. Niravkumar Patel*

*April 03, 2018*

# Project Overview

1. Implementing a variable admittance control scheme to increase the robot resistance when the sclera force is increasing a fixed upper level threshold
2. Using the expert's force-depth variation curve to apply another variable admittance control which helps operator to manipulate the eye
3. Applying these control schemes on the Eye-Robot and performing several experiments with different subjects

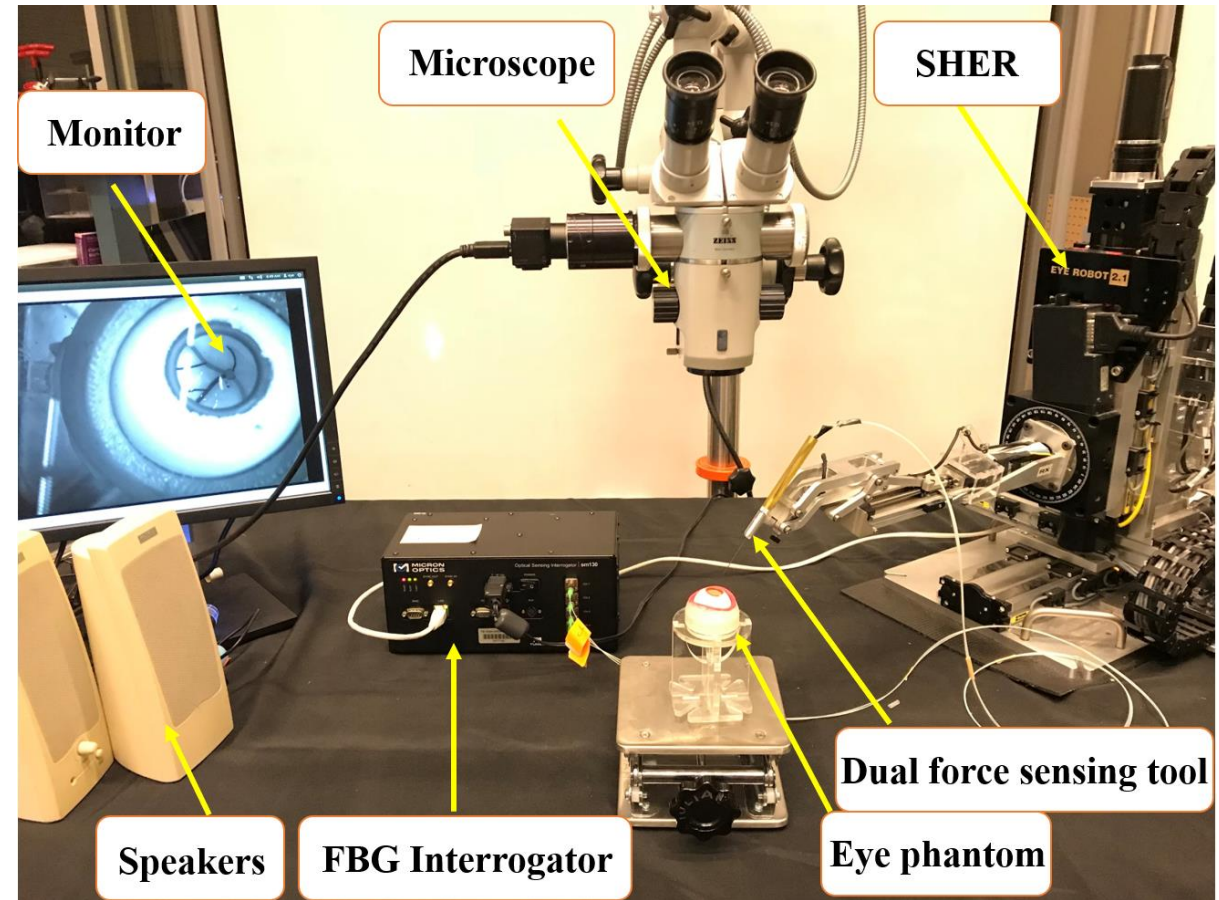

# Dependencies

---

No.	Dependency	Resolve by	Status	Plan B
1	Complete understanding of the problem and survey for possible approaches, based on feedback from mentors.	03/01/2018	Done	No Alternative
2	Procure eye-robot codebase	02/01/2018	Done	-
3	Stiffer and more accurate force-sensing tools	02/20/2018	Done	Using the current tool
4	Accurate real-time force sensing information, restore the full setup to state.	03/01/2018	Done	Filtering the non-accurate part of the data
5	Microscope	02/01/2018	Done	-
6	Moving stage for eye phantom	03/01/2018	Done	Building simpler stages
7	Doing preliminary experiments with surgeons	03/01/2018	Done	No Alternative

# Key Dates and Milestone (original)

---

- ✓ • 02/18 – Preparing the setup
- ✓ • 02/28 – Deciding about the control approach by talking to the mentors

## Minimum

- ✓ • 03/05 - Force data accuracy and reliability
- ✓ • 03/18 - Implementing the VAC algorithm and tuning
- ✗ • 03/28 - Experiments with 10 subjects based on VAC with the linear stage

## Expected

- ✓ • 04/06 – Obtaining the f-d relationship for an expert surgeon
- ✗ • 04/18 - Implementing the new VAC algorithm and tuning
- ✗ • 04/29 - Experiments with 5 subjects based on the new VAC with the linear stage

## Maximum

- ✗ • 05/10 – Performing the validation experiments with clinicians

# Linear stage for eye movement simulation

- Piezo-actuated linear stages having 3 linear degree of freedom
- The motion range for each axis is 6.5 mm
- The stage has been assembled and programmed to produce a random horizontal and vertical motion to simulate the eye movement.

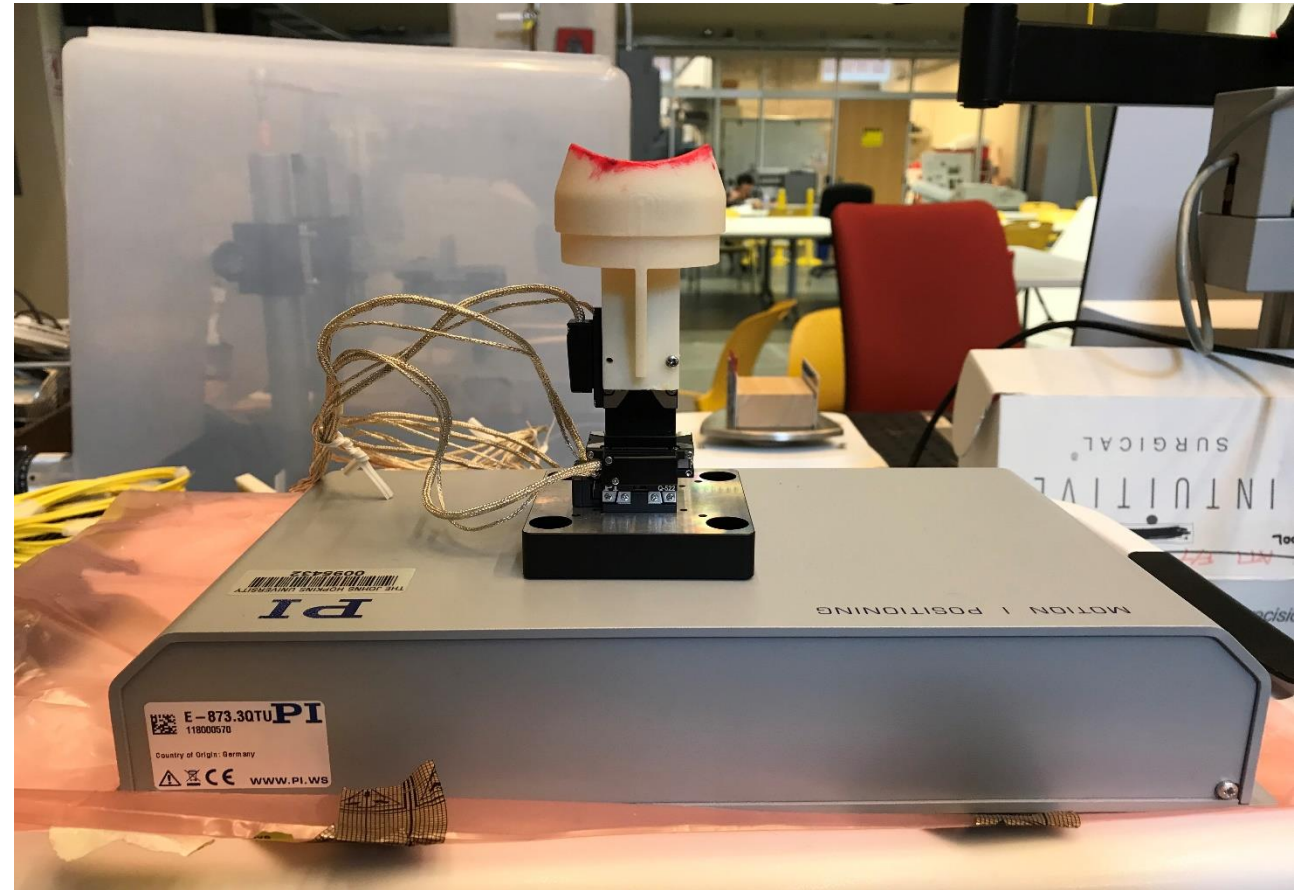

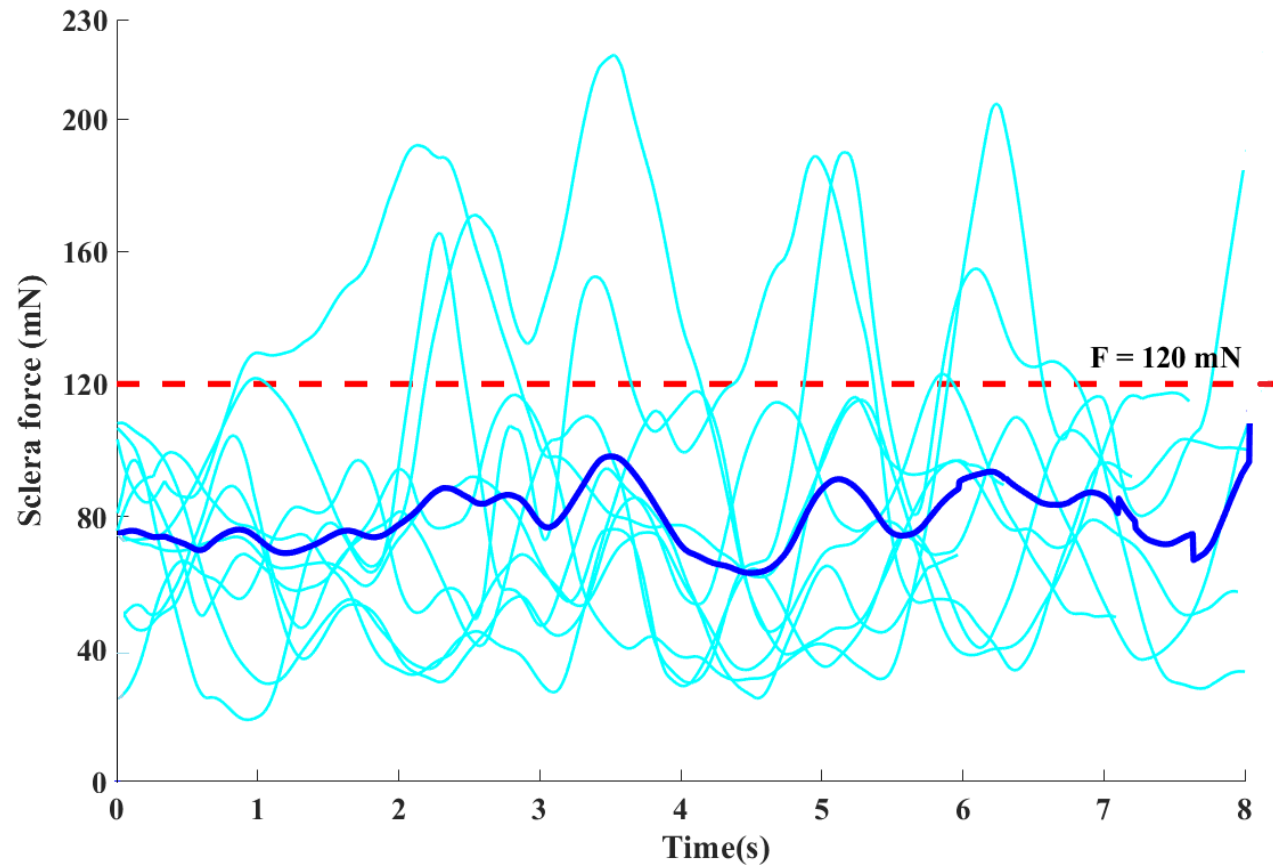

Preliminary experiments to determine the sclera safety level

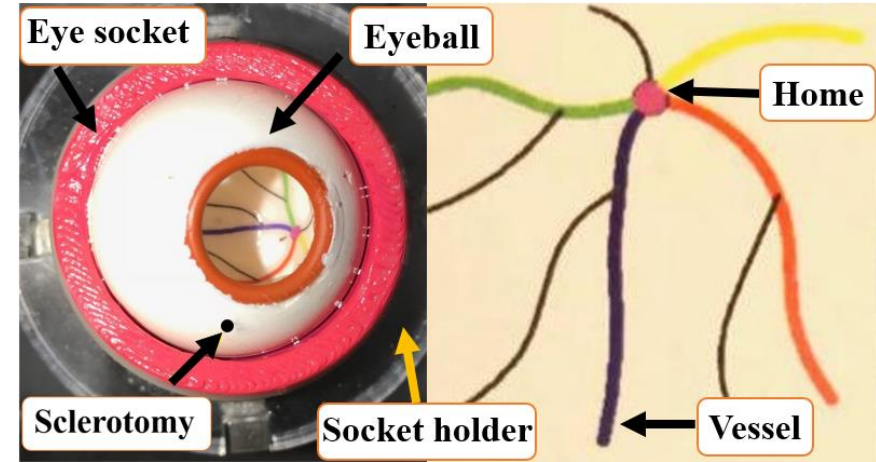

- 1) Subject rotates the eyeball and brings the tool tip on top of the home position in the vertical view.
- 2) An assistant reads one random sequence of four vessel colors for the subject. (e.g. yellow, red, blue, green)
- 3) The subject follows the vessels with the tool tip with the order specified in step 2 without touching the vessels.
- 4) After following all the vessels, the subject brings the eye configuration to a position similar to step.

# Admittance control for the minimum task

1- Haptic feedback with the threshold of 60 mN.  
The following gain is applied to have enough  
resistance at  $F = 120$  mN

$$\dot{x}_{des} = e^{0.1(-F_s+60)} \Lambda F_h \quad F_s > 60 \text{ mN} \longrightarrow$$

2- Audio feedback with 3 thresholds applied at  $F = 80$  mN,  $F = 100$  mN and  $F = 120$  mN

3- Without any sclera force feedback

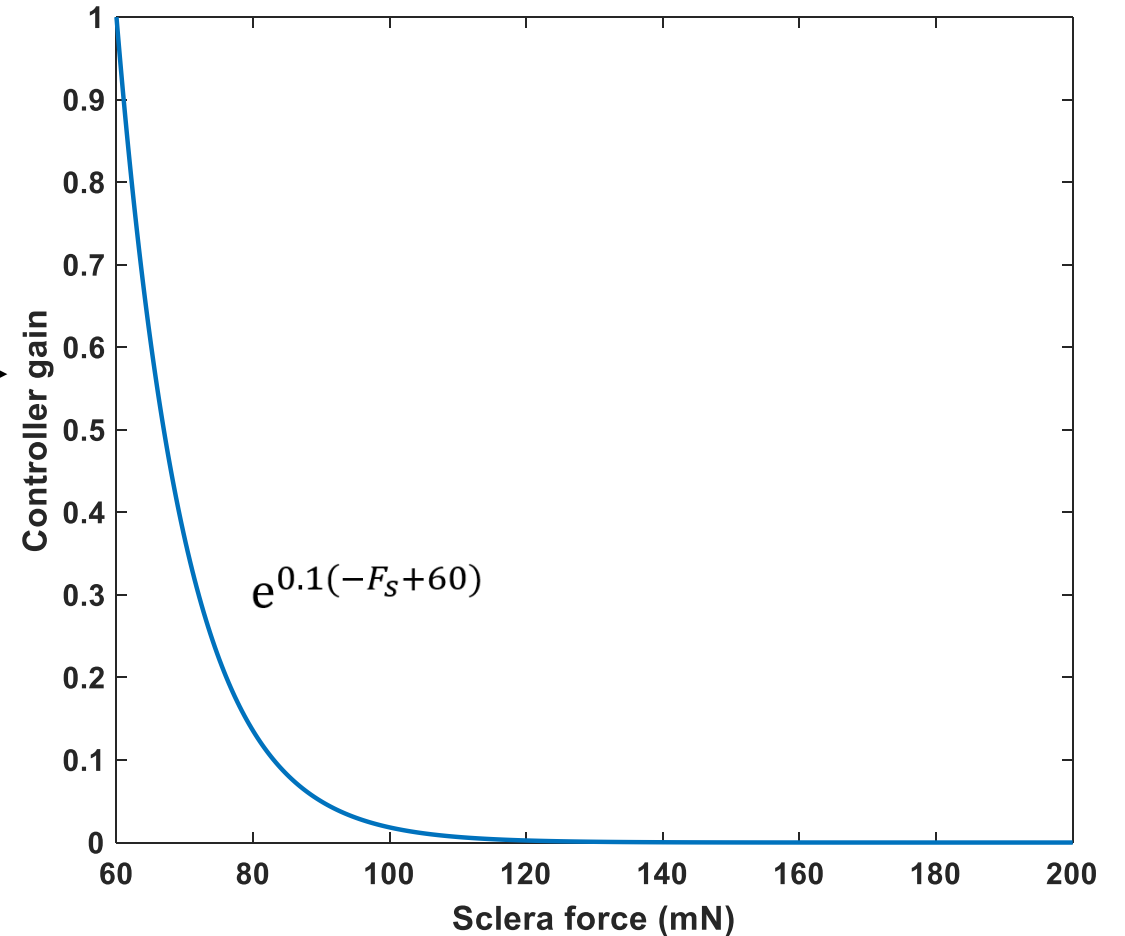

# Restrictions on the controller

---

- The tool can rotate freely with respect to the robot tool-holder
- Tool coordinate frame will change continuously relative to the robot wrist coordinate frame.
- Not having an encoder to measure the relative rotation between the tool and the robot wrist.

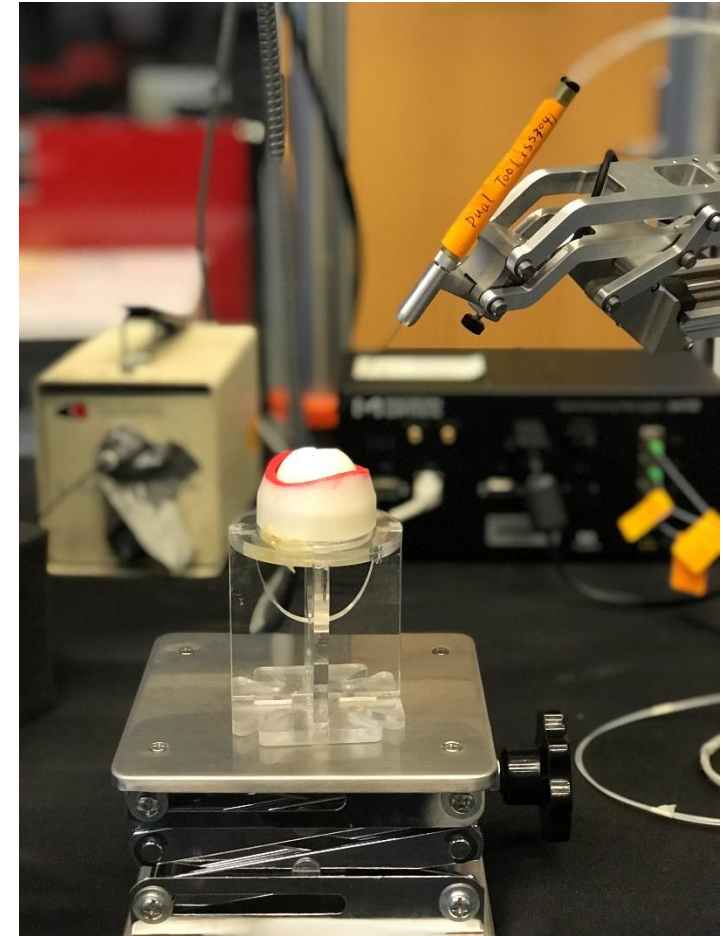



# Results after applying the force control

- The amount of time being spent on the forces more than 120 has decreased.
- Providing feedback has increased the sclera safety

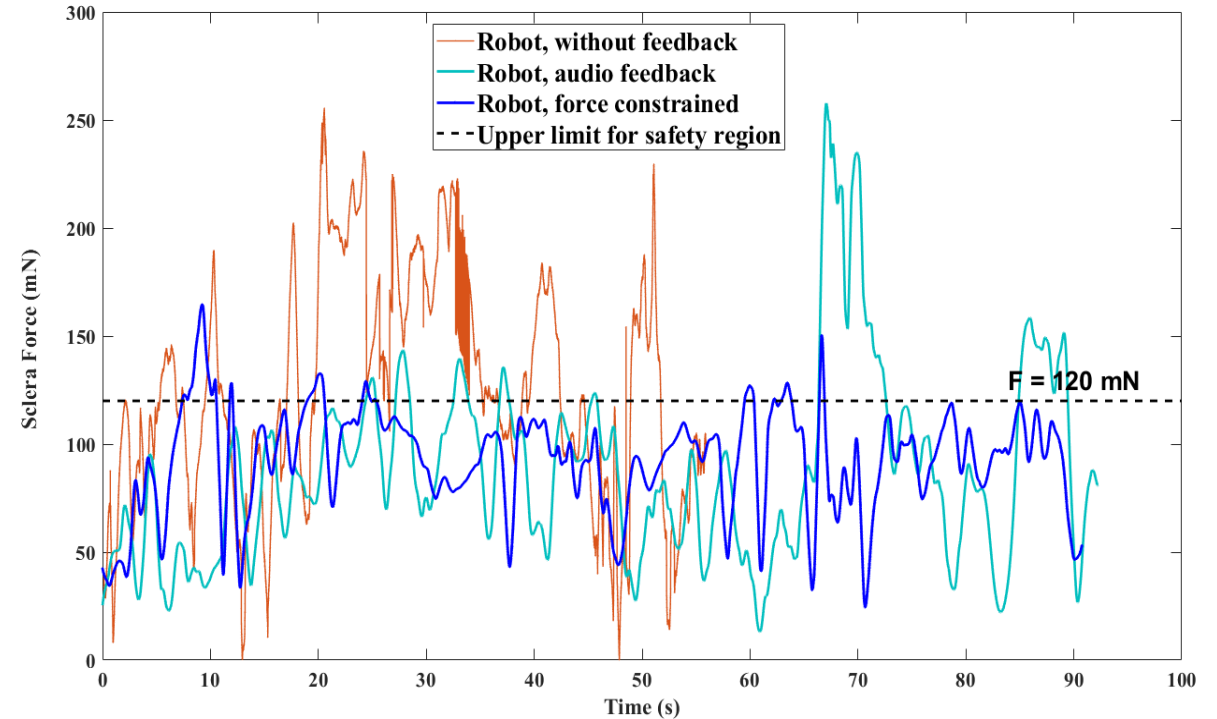

Typical results after applying the force control

# Admittance control for the minimum task

- Force-depth relationship has been obtained from a surgeon behavior
- Based on the F-D curve which has a variation similar to the next picture, we are going to integrate the next curve into the Admittance Controllers.

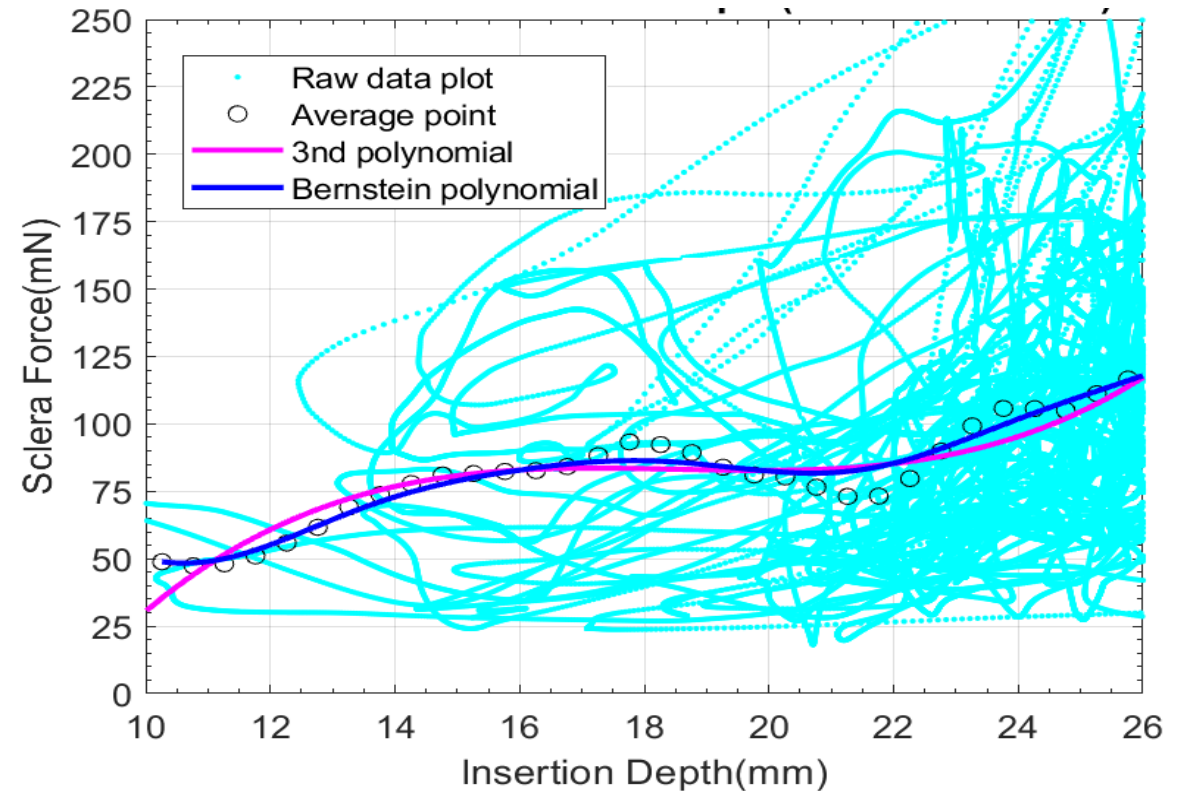

# Tasks related to the expected part

Two methods exist for reducing stress at the eye entry site during surgery:

- Using active software enforcement with visual or force-based feedback control to minimize tool-induced stress
- Physically constraining the surgical instrument about its incision point in the eye

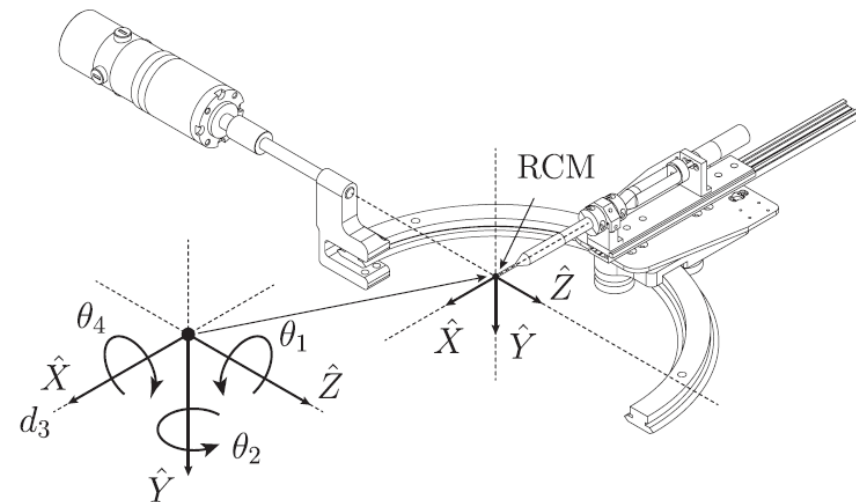
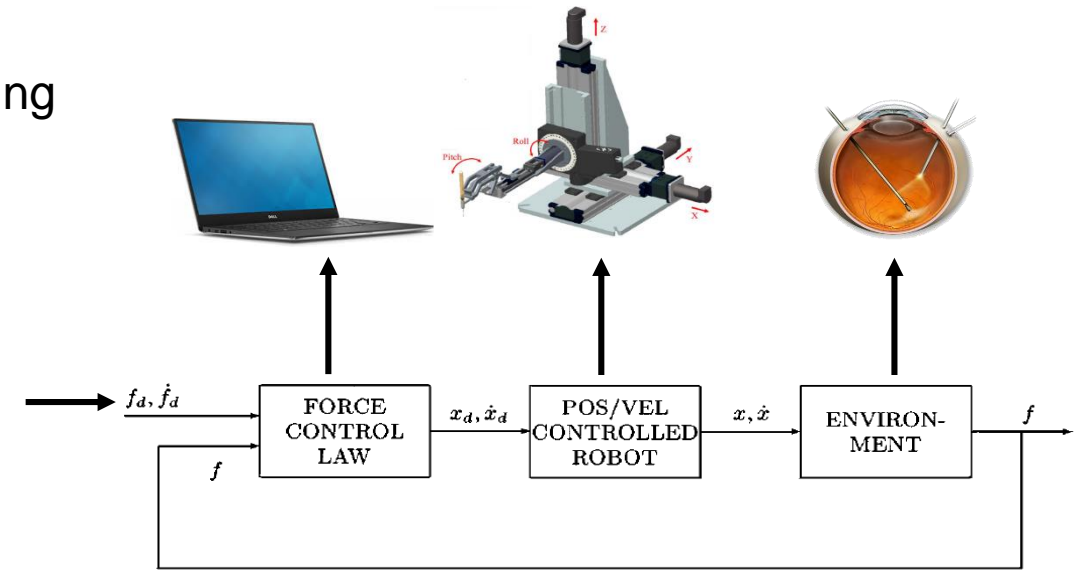

# Tasks related to the expected part

## Control law:

$$\dot{x}_d(t) = \hat{\gamma}(t) \dot{f}_d(t) - k_f \Delta f(t)$$

$$\dot{\hat{\gamma}}(t) = -\alpha \dot{f}_d(t) \Delta f(t)$$

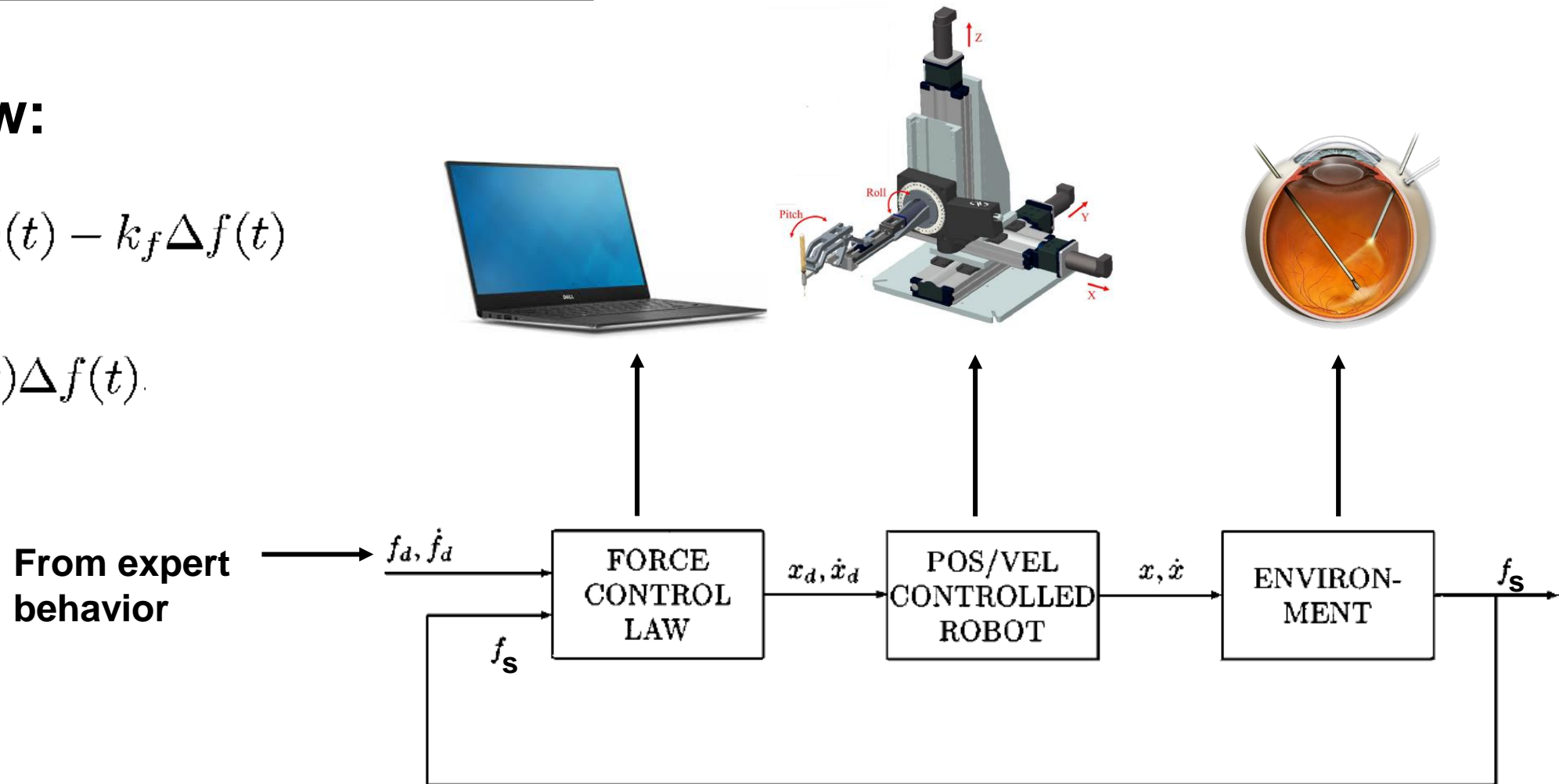

# Tasks related to the expected part

## Control law:

$$\dot{x}_{ss} = \alpha(A_{sh}F_{sh} + \gamma A_{ss}F_{hs})$$

$$A_{sh} = \text{diag}([1 - \beta, 1 - \beta, 1, 1, 1, 1]^T)$$

$$A_{ss} = \text{diag}([1 + \beta, 1 + \beta, 1, 1, 1, 1]^T)$$

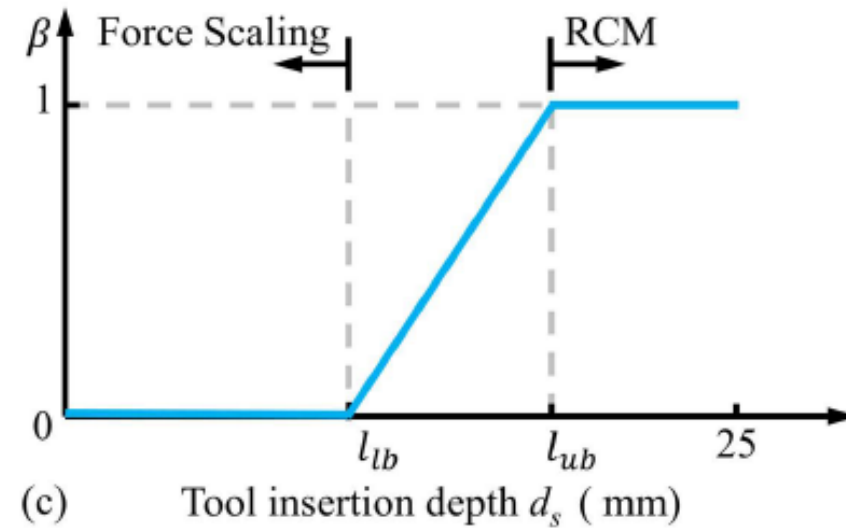
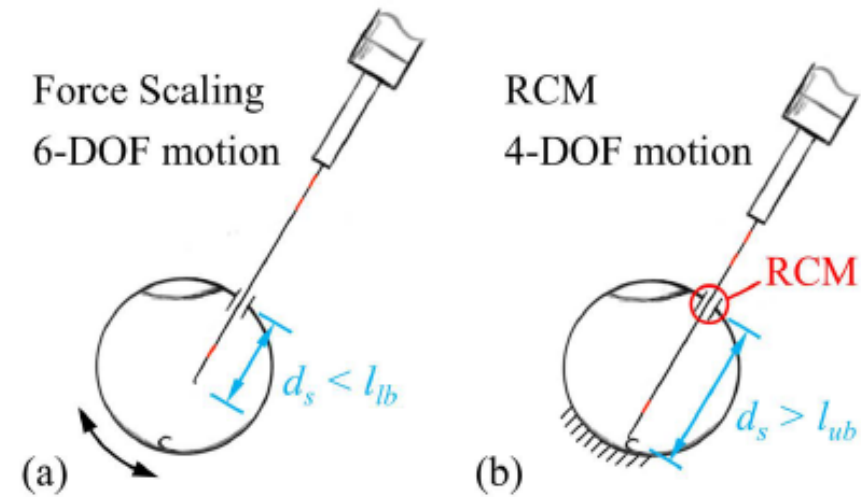

# Plan schedule modified

	April				May	
	1 <sup>st</sup> week	2 <sup>nd</sup> week	3 <sup>rd</sup> week	4 <sup>th</sup> week	1 <sup>st</sup> week	2 <sup>nd</sup> week
First VAC controller on the moving eye phantom						
Performing the experiments on the moving eye phantom						
Implementing the new methods of VAC						
Performing the preliminary experiments with the new control						
Performing the experiments with clinicians						
Preparing the poster						

# Bibliography

---

- Adaptive filtering, prediction and control, Graham C. Goodwin, Englewood Cliffs, N.J. : Prentice Hall, 2009
- A. Gijbels, E. B. Vander Poorten, P. Stalmans, and D. Reynaerts, “Development and experimental validation of a force sensing needle for robotically assisted retinal vein cannulations,” in Robotics and Automation (ICRA), 2015 IEEE International Conference on. IEEE,2015, pp. 2270–2276.
- J. T. Wilson, M. J. Gerber, S. W. Prince, C.-W. Chen, S. D. Schwartz, J.-P. Hubschman, and T.-C. Tsao, “Intraocular robotic interventional surgical system (iriss): Mechanical design, evaluation, and master–slave manipulation,” The International Journal of Medical Robotics and Computer Assisted Surgery, 2017.
- K. Willekens, A. Gijbels, L. Schoevaerdt, L. Esteveny, T. Janssens, B. Jonckx, J. H. Feyen, C. Meers, D. Reynaerts, E. Vander Poorten et al., “Robot-assisted retinal vein cannulation in an in vivo porcine retinal vein occlusion model,” Acta ophthalmologica, vol. 95, no. 3, pp. 270–275, 2017.

# Bibliography

---

- S. Tanaka, K. Harada, Y. Ida, K. Tomita, I. Kato, F. Arai, T. Ueta, Y. Noda, N. Sugita, and M. Mitsuishi, “Quantitative assessment of manual and robotic microcannulation for eye surgery using new eye model,” *The International Journal of Medical Robotics and Computer Assisted Surgery*, vol. 11, no. 2, pp. 210–217, 2015.